



# MICROWELL

European manufacturer of swimming pool dehumidifiers, heat pumps and germicidal air purifiers.



# 2025 PRICE LIST

Swimming pool HEATING &  
DEHUMIDIFICATION solutions  
UV Air Disinfection systems

**Valid from: FEBRUARY 13, 2025**

# WHY MICROWELL?

VARIETY OF MODELS  
 WIDEST RANGE OF DESIGN AND ACCESSORIES  
 EXCELLENT CRAFTSMANSHIP AND EXPERIENCE  
 INNOVATIVE ENGINEERING, CUTTING EDGE ROBOTICS  
 EUROPEAN QUALITY, LOCATED IN SLOVAKIA  
 750+ PARTNERS IN 40+ COUNTRIES  
 COMPETITIVE PRICES  
 ACCREDITED BY ISO 9001, ISO 14001, ISO 45001



## Dear Business Partners,

With great respect and gratitude, let us introduce our new Pricelist which is not only a showcase of our products, but also a reflection of our long-term efforts and determination to bring our customers the best solutions.

Our company Microwell has been operating on the market for more than 33 years, during which we have tried not only to keep up with technological developments, but also to exceed the expectations of you, our customers. This journey would not have been possible without your continued support and loyalty.

For many, the year 2024 was marked as a year full of challenges, unfortunately accompanied by some unfavorable economic and geopolitical factors. The ongoing conflict between Russia and Ukraine, economic and political instability of EU, significant inflation, etc. affected both global and local markets. Despite these difficult conditions, we at Microwell did not hesitate and continued to fulfill our vision, which is to bring top technological solutions to our customers.

In 2024, we reached an important milestone in the field of technology and innovation. We have built a specialized test chamber that enables thorough testing and improvement of our products. Even in this difficult time, we have successfully implemented a number of projects focused on technical-technological development and product design enhancement. This has resulted in several innovations listed in our product portfolio. In the field of pool dehumidifiers, we have introduced several important novelties such as SoundSteel technology/Improved noise reduction thanks to the double silent block, new generation of controllers, PV ready solution, new aluminum covers, DRY Orient design - Wi-fi and RS 485-485 (Modbus) option for DRY products for easier monitoring and management system.

Our next significant step was the introduction of a new line of HP SILVER Inverter Pro year-round swimming pool heat pumps. These products stand out not only for their technological excellence, but also for their attractive design, that meets the highest expectations of our customers.

## A look into the future

The year 2024 reminded us that even in uncertain times it is possible to grow, innovate and push the boundaries of what is possible. Our path is not easy, but thanks to the determination of our team and trust of our partners, we believe that a successful and promising future awaits us. Together, we will continue to deliver innovative solutions that improve lives and move our industry forward.

Sincerely,



Ing. Tibor Kovács, CEO

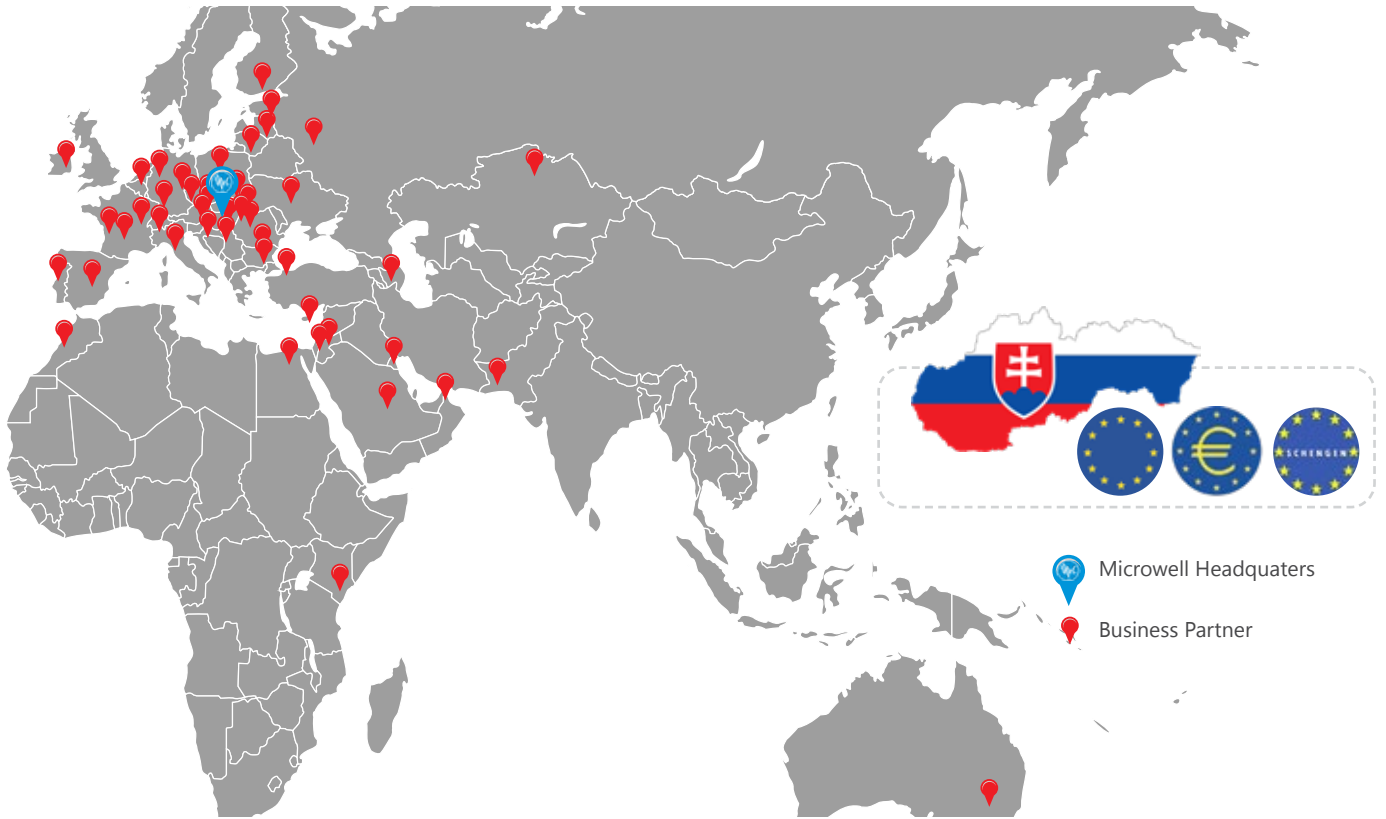

Microwell Headquarters  
 Business Partner



**MICROWELL Headquarters**

Microwell operates in 3 business divisions /Dehumidification, Heating and UV Air Disinfection Solutions, Measurement and Control, Air conditioning and Ventilation/, employs 70 employees in 5 Branch offices in 3 countries: Slovakia, Czech Republic, Hungary/. The company has own manufacturing facilities, warehouse, R&D department.



The core strength of Dehumidification, Heating and UV Air Disinfection Solutions Division is its R&D team, that works hard, permanently focused on customers needs, to find new solutions and innovations.



**Production & warehouse**

Primary manufacturing facility located in 3.000m<sup>2</sup> venue. Office extends over 1.260m<sup>2</sup>.



**NEW OFFICE**







# Germicidal Air Purifiers Pages 6 - 9

## ATHMOSS germicidal air purifier

ATHMOSS 120 OFFICE  
ATHMOSS 120 INDUSTRY  
ATHMOSSphere

8-9



# Dehumidifiers Pages 10 - 35

## SWIMMING POOL DEHUMIDIFIERS on the wall, on the floor, behind the wall

DRY 300 WAVE		
DRY 300 METAL / ALU	30m <sup>2</sup> /36l	14-15
DRY 300 SILVER		
DRY 400 WAVE		
DRY 400 METAL / ALU	45m <sup>2</sup> /48l	16-17
DRY 400 SILVER		
DRY 500 WAVE		
DRY 500 METAL / ALU	60m <sup>2</sup> /66l	20-21
DRY 500 SILVER		
DRY 800 WAVE		22
DRY 1200 WAVE	90-120m <sup>2</sup> /90-120l	
DRY 800 METAL / ORIENT		23
DRY 1200 METAL / ORIENT		24
DRY SALT+ SULPHUR+		

## SWIMMING POOL DEHUMIDIFIERS ducted

DRY 300 DUCT		
DRY 400 DUCT		
DRY 500 DUCT		
DRY 800 DUCT		26-29
DRY 1200 DUCT		

## SWIMMING POOL DEHUMIDIFIERS ceiling mounted

SIREN ECO MONO	60-120m <sup>2</sup> /67-134l	30
SIREN ECO DUE		32
DRY HORIZON		

## DEHUMIDIFIERS FOR GALLERIES

DRY GALLERY		34
-------------	--	----

## DEHUMIDIFIERS FOR INDUSTRY

T40   T90   T120		35
TE40   TE90   TE120		

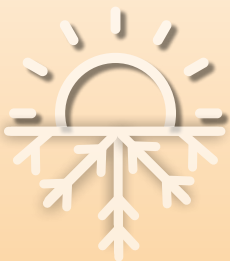

# Heat pumps Pages 36 - 59

## SWIMMING POOL HEAT PUMPS ON/OFF /up to 120 m<sup>3</sup>/

HP 2300 INVENTOR	23-28kW/80-120m <sup>3</sup>	42-43
HP 2800 INVENTOR		

## SWIMMING POOL HEAT PUMPS SEASONAL INVERTER /up to 50 m<sup>3</sup>/

HP 900 BLACK	9kW/30m <sup>3</sup>	46
HP 1100 BLACK	11.5kW/35m <sup>3</sup>	46
HP 1500 BLACK	15kW/50m <sup>3</sup>	47

## SWIMMING POOL HEAT PUMPS FULL YEAR INVERTER /up to 135 m<sup>3</sup>/

HP 1100 SILVER Inverter Pro	11kW/40m <sup>3</sup>	48
HP 1500 SILVER Inverter Pro	15kW/60m <sup>3</sup>	49
HP 1800 SILVER Inverter Pro	18kW/95m <sup>3</sup>	50
HP 2100 SILVER Inverter Pro	21kW/105m <sup>3</sup>	51
HP 2800 SILVER Inverter Pro	28kW/135m <sup>3</sup>	52

## SWIMMING POOL HEAT PUMPS FULL YEAR PREMIUM /up to 120 m<sup>3</sup>/

HP 2400 PREMIUM	24kW/80m <sup>3</sup>	
HP 3000 PREMIUM	30kW/120m <sup>3</sup>	54-55

## COMMERCIAL SWIMMING POOL HEAT PUMPS INVERTER /up to 520 m<sup>3</sup>/

MAX 50 - 450	50-450kW/260-520m <sup>3</sup>	56
iMAX 50-450		



# Accessories & Spare parts Pages 60 - 75

QMAX-HEAT PUMP TESTER		61
HUMIDITY VISUALIZATION microLIGHT+		63
INSTALLATION MATERIAL AND EQUIPMENT FOR INSTALLATION AND SERVICE		65
WATER SURFACE COVER		73
VENTILATION		74



# NEW IN 2025

## SILVER INVERTER PRO

The Silver Inverter Pro brings year-round heating and cooling with capacities of 11, 15, 17, 21, and 28 kW in monoblock and split configurations. Its advanced airflow system ensures quiet, efficient performance, while prototypes with R290 (Propane) lead the way to a greener future.

Experience efficiency and sustainability with the Silver Inverter Pro.

Full model line read on **pages 48-52.**

## SILVER INVERTER PRO



NEW IN 2025

## NEW CONTROLLER



## NEW CONTROLLER

Our new smart controller combines advanced technology with user-friendly features. It includes a sleek touchscreen display, built-in Wi-Fi for seamless smart home integration, and RS-485 connectivity for Modbus communication. Fully customizable, it allows precise control of drying, fan management, and other accessories, making it an ideal solution for modern automation needs. Designed for efficiency and versatility, it's the perfect upgrade for Microwell dehumidifiers.

## DRY ALU

All Microwell Dry 300, 400, and 500 dehumidifiers will feature aluminum covers, replacing steel. This upgrade offers:

- Higher Corrosion Resistance: Ideal for pool environments.
- Lighter Weight: Easier transport and installation.
- Improved Ventilation Design: Enhanced air circulation for optimal performance.

Experience the next level of durability and efficiency with our upgraded dehumidifiers.

Full model line read on **pages 15-21.**

## ALUMINIUM COVER

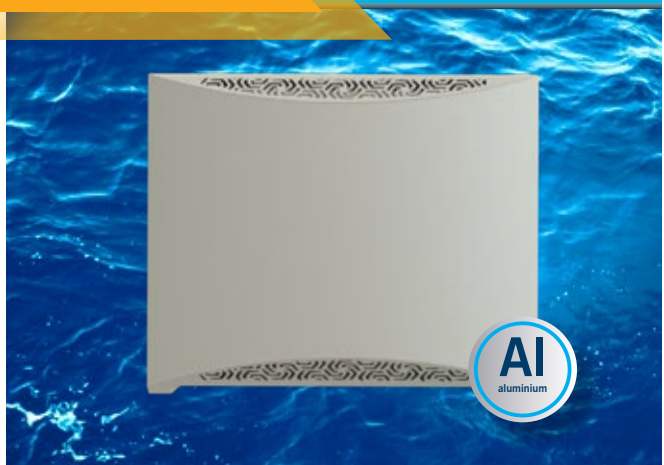

**ATHMOSS**  **ATHMOSSphere**

*The essential presence of the future.*



## Germicidal air purifiers

For offices, waiting rooms, retirement houses, event, fitness and shopping centers.

For industry premises, production halls.

**Professional, powerful  
Air purifier & Disinfector  
safe to use at presence of people**

Destroys viruses, bacteria and other microorganisms in the air.

The ATHMOSS germicidal air purifier will create a safe and healthy environment in your office, production hall or doctor's waiting room.



Series	ATHMOSS 120	ATHMOSS 120	ATHMOSSphere
Model	OFFICE	INDUSTRY	
Installation	wall mounted/on the floor with mobile stand		ceiling mounted
Recommended size of disinfected area	15-450 m <sup>3</sup>	25-600 m <sup>3</sup>	100-1000 m <sup>3</sup>
Dimensions /WxHxD/	770 x 660 x 260 mm		Ø 1210 x 278 mm
Weight	20.5 kg	21.5 kg	
Cover	Acrylic, white		Acrylic, white
Noise level	33.5 dB(A) MIN 45.8 dB(A) MAX	39.1 dB(A) MIN 58.2 dB(A) MAX	34 dB(A) MIN 62 dB(A) MAX
Air flow	50-495 m <sup>3</sup> /h, adjustable	50-700 m <sup>3</sup> /h, adjustable	400-800 m <sup>3</sup> /h, adjustable
Power supply	230V AC/50Hz/1ph		230V AC/50Hz/1ph
Consumption	95-100-152 W	188-237 W	270-380 W
Number and performance of UV-C tubes	6 x 15 W /253.7 nm UV-C/		12 x 15 W /253.7 nm UV-C/
Operating life-time of UV-C tubes	<9000h		<9000h
Prefilter	Class G3 >10µm		Class G3 >10µm
HEPA filter	Class H11 >0.3µm, 95%		Class H11 >0.3µm, 95%

Manufacturer notice: Manufacturer reserves the right to change the technical parameters without notice.

## Tested and confirmed by the Institute of Clinical Microbiology, Faculty of Medicine UK in Hradec Králové, Czech Republic.



Effect of the air purifier ATHMOSS INDUSTRY 120 on artificial contaminated laboratory air pollution of bacteria - 47m<sup>3</sup>

Effect of the air purifier ATHMOSSphere on artificial contaminated laboratory air pollution of bacteria - 126m<sup>3</sup>

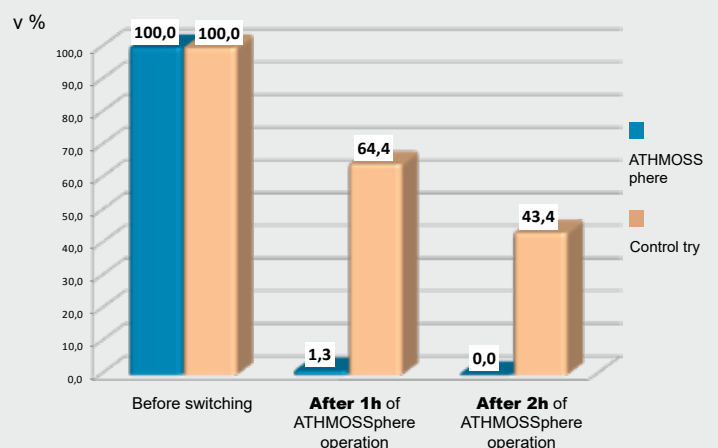
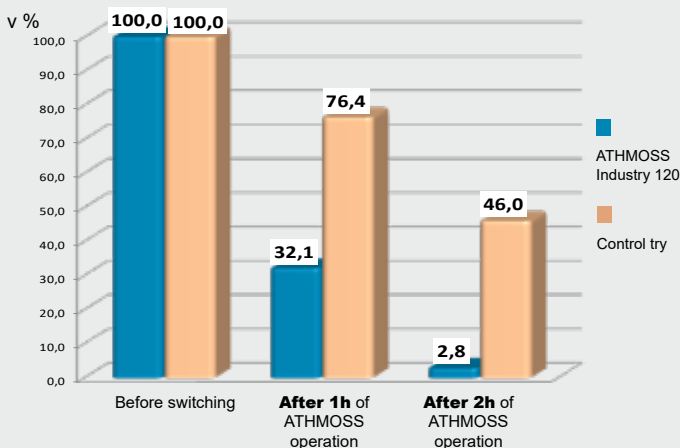



90W  
495 m<sup>3</sup>**ATHMOSS 120 OFFICE***Quiet, yet effective.*90W  
700 m<sup>3</sup>**ATHMOSS 120 INDUSTRY***Powerful without compromise.*

Cover	Acrylic, white	
UV-C tubes	6x15W /253,7 nm/	
Air flow	50-495 m <sup>3</sup> /h	50-700 m <sup>3</sup> /h
Prefilter	Class G3 >10 µm	
HEPA filter	Class H11 >0,3 µm, 95%	
microMETAL+ stainless steel filter		
Installation	Wall mounted	

ATHMOSS **ATHMOSS 120 O** - **1.****ATHMOSS 120 I** - **1.**

Basic equipment:	Model:	Price EXW Sala, SK w/o VAT
Germicidal air purifier, wall console, 90W UV-C <9.000hrs, G3 prefilter, H11 95% HEPA filter, microMETAL+ stainless steel filter, user's manual	<b>ATHMOSS 120 OFFICE</b>	<b>1 980 €</b>
	<b>ATHMOSS 120 INDUSTRY</b>	<b>2 150 €</b>

1. Installation:		
<b>S</b> Standard: on the wall		<b>0 €</b>
<b>M</b> Mobile stand (vertically adjustable 145-185cm), RAL9010 white, 4 wheels (2 lockable): <i>/Rebate does not apply on this item. This is the actual purchase price./</i>		<b>115 €</b>
<b>P</b> Through-the-wall installation (Fiberglass cover with through-the-wall ducts set and removable aluminium grills, metal duct galvanized, wall thickness >400mm, insulated)		<b>385 €</b>

Spare parts:		Price EXW Sala, SK w/o VAT
Spare Disinfection chamber with 90W UV-C, with microMETAL+ stainless steel filter and HEPA filter H11		<b>760 €</b>
HEPA filter H11, 1pc, >0.3µm, 95% <i>/Rebate does not apply on this item. This is the actual purchase price./</i>		<b>15 €</b>
Pre-filter class G3, package of 3pcs, >10µm <i>/Rebate does not apply on this item. This is the actual purchase price./</i>		<b>9 €</b>

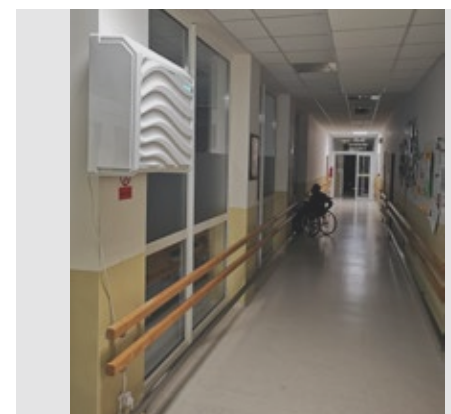
**1-M****1-P**EURO PALETTE packed, FUMIGATED  
**17.50€/1pc** (Depending on the model it is possible to pack more units on EUP (2-6pcs).)

180W  
495 m<sup>3</sup>

# ATHMOSSphere

The essential presence of the future.

# ATHMOSSphere

Cover	Acrylic, white
UV-C tubes	12x15W /253,7 nm/
Air flow	400-800 m <sup>3</sup> /h adjustable
Prefilter	Class G3 >10 µm
HEPA filter	Class H11 >0,3 µm, 95%
microMETAL+ stainless steel filter	
Installation	Ceiling mounted

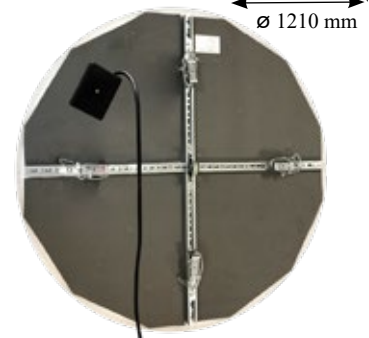

GERMICIDAL AIR PURIFIER

## ATHMOSSphere

### Basic equipment:

Price EXW Sala, SK  
w/o VAT

Ceiling germicidal air purifier, 180W UV-C <9.000hrs, G3 prefilter, H11 95% HEPA filter, microMETAL+ stainless steel filter, ceiling lifting mechanism, user's manual

3 150 €

### Spare parts:

Price EXW Sala, SK  
w/o VAT

Spare Disinfection chamber with 180W UV-C, with microMETAL+ stainless steel filter and HEPA filter H11

1 250 €

HEPA filter H11, 1pc, >0.3µm, 95%  
*/Rebate does not apply on this item. This is the actual purchase price./*

15 €

Pre-filter class G3, package of 3pcs, >10µm  
*/Rebate does not apply on this item. This is the actual purchase price./*

9 €



EURO PALETTE packed, FUMIGATED  
**17.50€/1pc**  
(Depending on the model it is possible to pack more units on EUP (2-6pcs).)



v. 01/2025

 **MICROWELL**



# Dehumidifiers

For swimming pools, hotel pools, spa and jacuzzi  
For galleries, museums and libraries  
For industry

**LIFETIME**  
WARRANTY ON  
CONDENSING TRAY

**5 YEAR**  
WARRANTY ON  
COMPRESSOR

**3 YEAR**  
GENERAL  
WARRANTY ON  
SPARE PARTS



























## Swimming pool humidity under control

Microwell dehumidifiers solve humidity problems and maintain healthy pool environment by removing condensation and wet wall odour, and providing free heating through heat recovery.

Working on the principle of condensation, DRY swimming pool dehumidifiers are removing humid air from swimming pool hall, replacing it with dry and warm air.



# MICROWELL DRY Line 2025

		Pool surface	Extraction rate	Extraction rate	Air flow	Noise level (at 1m distance)	Power consumption	Heating output	Dimensions netto	Weight netto
	Model	m <sup>2</sup>	l/24hrs /60% RH, 30°C/	l/24hrs /80% RH, 30°C/	m <sup>3</sup> /h	dB(A)	W	W	mm	kg
Economy class - WAVE	 <b>DRY 300 WAVE</b>	30	36	48	550	42	700	1900	780 x 660 x 255	40
	 <b>DRY 400 WAVE</b>	45	48	58	600	42	700	1900	780 x 660 x 255	40
	 <b>DRY 500 WAVE</b>	60	66	101	800	44	1000	3500	1245 x 660 x 255	60
	 <b>DRY 800 WAVE</b>	90	90	136	1100	46	1600	5100	1250 x 950 x 310	80
	 <b>DRY 1200 WAVE</b>	120	120	181	1200	46	2150	5250	1250 x 950 x 310	82
Premium class - METAL/ALUMINIUM	 <b>DRY 300 METAL / ALU</b>	30	36	48	550	42	700	1900	780 x 642 x 300	43
	 <b>DRY 400 METAL / ALU</b>	45	48	58	600	42	700	1900	780 x 642 x 300	43
	 <b>DRY 500 METAL / ALU</b>	60	66	101	800	44	1000	3500	1245 x 642 x 300	65
	 <b>DRY 800 METAL</b>	90	90	136	1100	46	1600	5100	1250 x 950 x 310	100
	 <b>DRY 1200 METAL</b>	120	120	181	1200	46	2150	5250	1250 x 950 x 310	101
LUXURY class - STAINLESS STEEL	 <b>DRY 300 SILVER</b>	30	36	48	550	42	700	1900	780 x 642 x 300	50
	 <b>DRY 400 SILVER</b>	45	48	58	600	42	700	1900	780 x 642 x 300	50
	 <b>DRY 500 SILVER</b>	60	66	101	800	44	1000	3500	1245 x 642 x 300	77
Through-the-wall - Concealed	 <b>DRY 300 TTW</b>	30	36	48	550	42	700	1900	880 x 658 x 240	56
	 <b>DRY 400 TTW</b>	45	48	58	600	42	700	1900	880 x 658 x 240	56
	 <b>DRY 500 TTW</b>	60	66	101	800	44	1000	3500	1245 x 660 x 255	60
	 <b>DRY 800 TTW</b>	90	90	136	1100	46	1600	5100	1247 x 950 x 300	100
	 <b>DRY 1200 TTW</b>	120	120	181	1200	46	2150	5250	1247 x 950 x 300	103
Ducted - To air ducting	 <b>DRY 300 DUCT</b>	30	32	43	500/200Pa	54	800	1900	880 x 658 x 240	56
	 <b>DRY 400 DUCT</b>	40	43	56	500/200Pa	54	800	1900	880 x 658 x 240	56
	 <b>DRY 500 DUCT</b>	50	52	68	1000/200Pa	56	1150	3500	1250 x 660 x 250	78
	 <b>DRY 800 DUCT</b>	80	88	135	1100/170Pa	58	1700	5100	1247 x 950 x 300	102
	 <b>DRY 1200 DUCT</b>	110	112	170	1200/145Pa	60	2250	5250	1247 x 950 x 300	103
Ceiling	 <b>DRY HORIZON 800</b>	90	94	141	1150	58	2000	5100	1083 x 742 x 540	102
	 <b>DRY HORIZON 1200</b>	120	127	194	1800	64	2300	5300	1083 x 742 x 540	108
	 <b>SIREN Eco MONO</b>	60	67	104	1000	35	1000	4500	Ø 1210 x 278	53+20
	 <b>SIREN Eco DUE</b>	120	134	208	2000	35	2300	8750	2x Ø 1210x 278	2x53+30

The manufacturer reserves the right to change the parameters without notice.



# REIMAGINED, REDESIGNED, REINVIGORATED

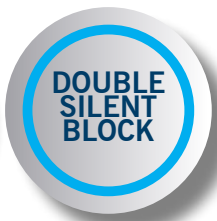

## 2025 NEW DESIGN

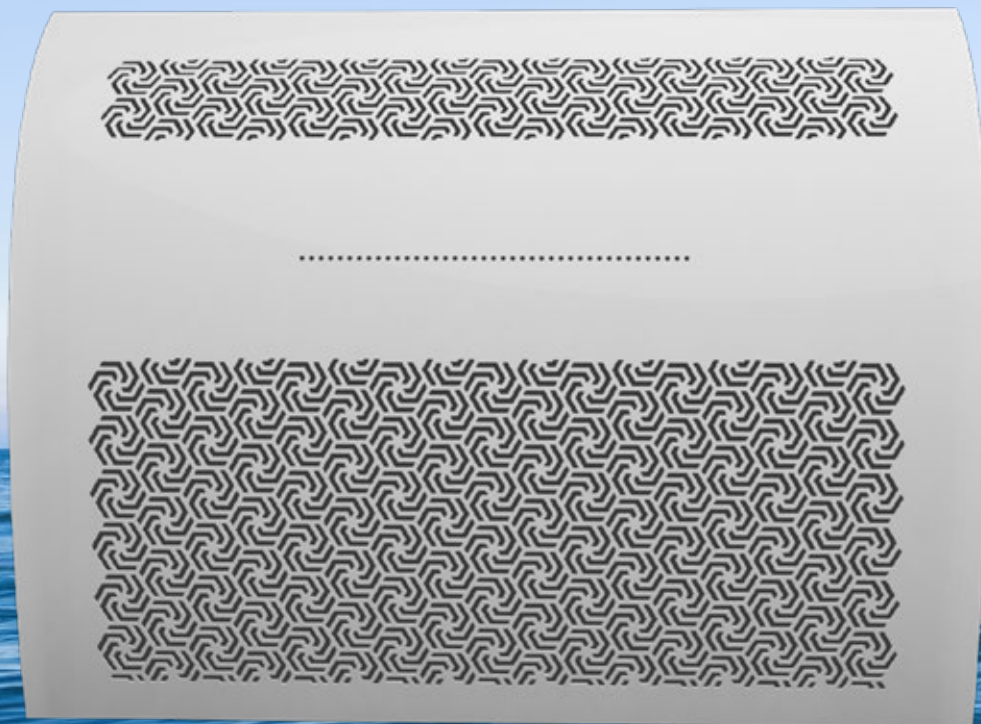

## Microwell DRY Series swimming pool dehumidifiers come equipped with these features as standard:

- Touch digital controller
- WiFi
- Self-diagnosis
- RS-485 (ModBus)
- Passive defrosting - function available from +9°C
- Full functionality for all other accessories (heating, boiler control, PV ready, DRY contact, etc.), which can also be used after the device is installed
- For METAL/ALU models, the casing is made of aluminum (previously steel) - lower weight and higher corrosion resistance
- Double silent block for the compressor + additional noise reduction using SoundSteel material

# LIGHTER THAN EVER





**36 l**  
**30 m<sup>2</sup>**

# DRY 300 WAVE

Cover	Extraction rate (30°C/60% RH - 35°C/95% RH)	Air flow
plastic (acryl)	36-63 l/24hrs	550 m <sup>3</sup> /hour

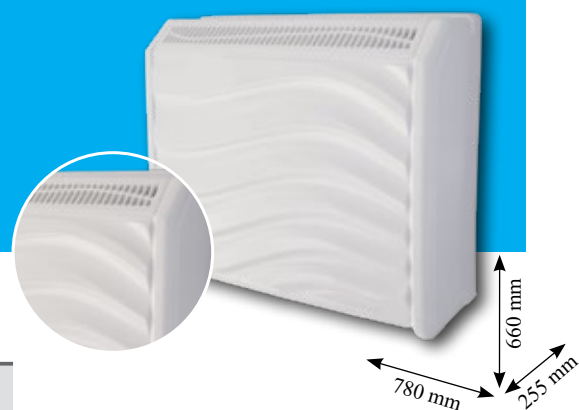

## DRY 300W - 1. - 2. - 3. - 4. - 5. - 6. - 7. - 8.

### Basic equipment:

Dehumidifier, wall console, user's manual, installation layout, fixation screws, step inverter fan

microCOMPRESSOR+ ultra QUIET+ easy INSTALL+



**Price EXW**  
w/o VAT /EUR/

**2 890**

### 1. Installation:

<b>S</b> standard: on the wall	0
<b>M</b> mobile stand, 4 wheels, white color (RAL 9010), 230V EURO plug, 2m	235
<b>F</b> fixed floor stand, color: white RAL9010 - matching the color of the main unit, 230V EURO plug, 2m	260
<b>P</b> through-the-wall INDOOR INSTALLATION (fiberglass cover with TTW ducts set and removable aluminum grills, metal ducts galvanized, insulated)	595
<b>T Premium</b> through-the-wall INDOOR INSTALLATION (metal powder coated cover, wall ducts, removable grills, metal ducts galvanized, insulated)	1 390
<b>E</b> through-the-wall OUTDOOR INSTALLATION (40mm TTW external aluminum and rubber insulation, winter module, condensate tray defrost, -15°C), fiberglass cover	1 350

### 2. Control:

<b>S</b> standard: built-in digital touch controller with WiFi and RS-485 (Modbus)	0
<b>E</b> remote wireless humidistat & thermostat DRY EASY 300 + built-in touch controller with WiFi and RS-485 (Modbus)	345
<b>W6</b> remote wired humidistat EBERLE HYG6001+built-in touch controller	120
<b>W7</b> remote wired humidistat & thermostat EBERLE HYG7001+built-in touch controller	140

### 3. Air temperature:

<b>S</b> standard: +9°C...+36°C	0
<b>V</b> +9°C...+42°C (high temperature set)	259
<b>F</b> +5°C...+35°C (low temperature set with 4-way valve hot gas defrost)	385

### 4. Air heating:

<b>S</b> standard: without LPHW (Low Pressure Hot Water)	0
<b>H</b> LPHW, 3.5 kW, without regulation	228
<b>V</b> LPHW, 3.5 kW, with solenoid valve, fully automated regulation	442
<b>E</b> Electrical heating 2 kW	490

### 5. LPHW connection:

<b>S</b> standard: N/A (without LPHW)	0
<b>B</b> from the back	0
<b>R</b> from right	0
<b>L</b> from left	0

### 6. microLIGHT+

<b>S</b> standard: without Pool Security microLIGHT+	0
<b>L</b> Pool Security microLIGHT+	140

### 7. Air filter:

<b>S</b> standard: without air filter	0
<b>F</b> Air filter (for model with wall or mobile stand installation: 1-S/M/F option)	52
<b>C</b> Air filter grid (for model with TTW installation: 1-P/E option) (G3 class)	52

### 8. Fresh air supply:

<b>S</b> standard: without fresh air supply	0
<b>F</b> adapter, Ø 100 mm, 50 mm length, galvanized	35



EURO PALETTE packed, FUMIGATED  
**17.50€/1pc** (Depending on the model it is possible to pack more units on EUP (2-6pcs).)

36 l  
30 m<sup>2</sup>

# DRY 300 METAL / ALU | DRY 300 SILVER

Cover	Cover	Extraction rate	Air flow
DRY 300 METAL / ALU	DRY 300 SILVER	(30°C/60% RH - 35°C/95% RH)	
aluminium	stainless steel	36-63 l/24hrs	550 m <sup>3</sup> /hour



DRY 300M

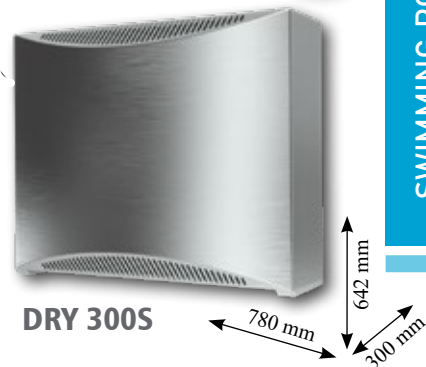

DRY 300S

SWIMMING POOL DEHUMIDIFIERS

DRY 300M - 1. - 2. - 3. - 4. - 5. - 6. - 7. - 8. - 9.

DRY 300S - - 2. - 3. - 4. - 5. - 6. - 7. - 8. - 9.



Wi-Fi included

100% corrosion free

Basic equipment:	Model:	Price EXW w/o VAT /EUR/
Dehumidifier, wall console, user's manual installation layout, fixation screws, step inverter fan	<b>DRY 300 METAL / ALU</b>	<b>3 380</b>
micro COMPRESSOR+ ultra QUIET+ easy INSTALL+	<b>DRY 300 SILVER</b>	<b>4 370</b>

<b>1. Color options:</b>		
<b>W</b> standard: white (RAL9010)		0
<b>S</b> silver color ,Silver grey' - Tiger		85
<b>C</b> color selection according to your preference (RAL code) - 200+ colors		price on demand
<b>2. Installation:</b>		
<b>S</b> standard: on the wall		0
<b>M</b> mobile stand, 4 wheels, color: silver 'Tiger', white (RAL 9010), 230V EURO plug, 2m		235
<b>F</b> fixed floor stand, color: black RAL9005, 230V EURO plug, 2m		260
<b>3. Control:</b>		
<b>S</b> standard: built-in digital touch controller with WiFi and RS-485 (Modbus)		0
<b>E</b> remote wireless humidistat & thermostat DRY EASY 300 + built-in touch controller with WiFi and RS-485 (Modbus)		345
<b>W6</b> remote wired humidistat EBERLE HYG6001+built-in touch controller		120
<b>W7</b> remote wired humidistat & thermostat EBERLE HYG7001+built-in touch controller		140
<b>4. Air temperature:</b>		
<b>S</b> standard: +9°C...+36°C		0
<b>V</b> +9°C...+42°C (high temperature set)		259
<b>F</b> +5°C...+35°C (low temperature set with 4-way valve hot gas defrost)		385
<b>5. Air heating:</b>		
<b>S</b> standard: without LPHW (Low Pressure Hot Water)		0
<b>H</b> LPHW, 3.5 kW, without regulation (external no current contact)		228
<b>V</b> LPHW, 3.5 kW, fully automatic regulation (with solenoid valve + external no current contact)		442
<b>E</b> Electrical heating 2 kW		490
<b>6. LPHW connection:</b>		
<b>S</b> standard: N/A (without LPHW)		0
<b>B</b> from the back		0
<b>R</b> from right		0
<b>L</b> from left		0
<b>7. micro LIGHT+</b>		
<b>S</b> standard: without Pool Security microLIGHT+		0
<b>L</b> Pool Security microLIGHT+		140
<b>8. Air filter:</b>		
<b>S</b> standard: without air filter		0
<b>F</b> Air filter		52
<b>9. Fresh air supply:</b>		
<b>S</b> standard: without fresh air supply		0
<b>F</b> adapter, Ø 100 mm, 50 mm length, galvanized		35

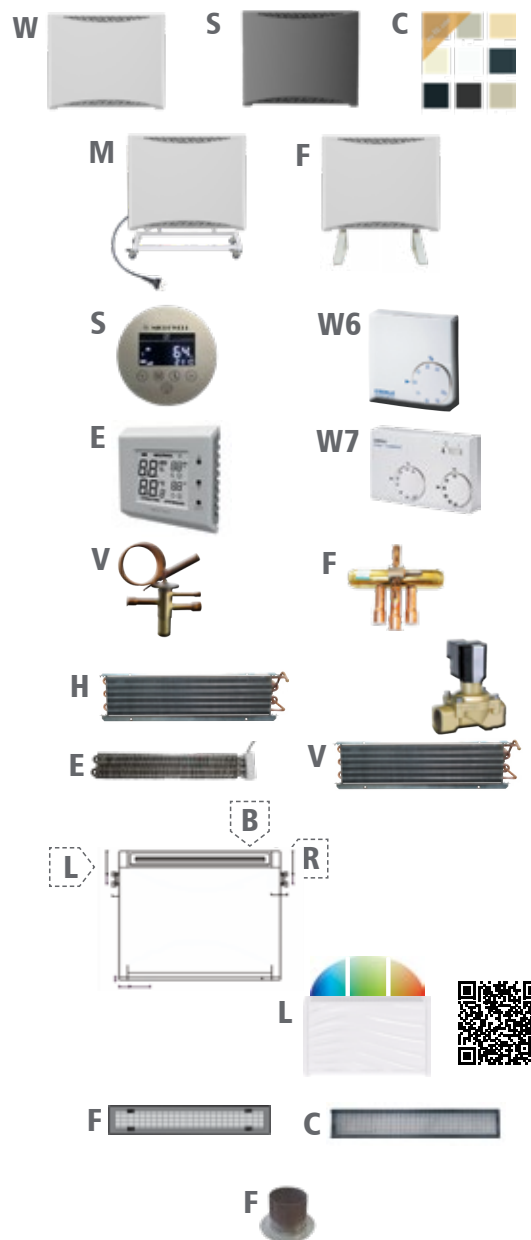

EURO PALLETTE packed, FUMIGATED  
**17.50€/1pc** (Depending on the model it is possible to pack more units on EUP (2-6pcs).)



v. 01/2025

MICROWELL

48 l  
45 m<sup>2</sup>

# DRY 400 WAVE

Cover	Extraction rate (30°C/60% RH - 35°C/95% RH)	Air flow
plastic (acryl)	48-78 l/24hrs	600 m <sup>3</sup> /hour

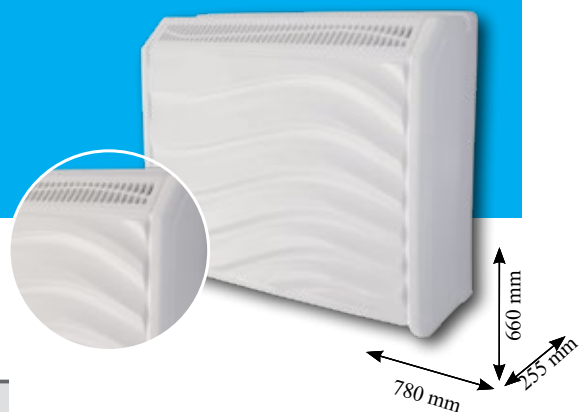

## DRY 400W - 1. - 2. - 3. - 4. - 5. - 6. - 7. - 8.

### Basic equipment:

Dehumidifier, wall console, user's manual, installation layout, fixation screws, step inverter fan



Price EXW  
w/o VAT /EUR/

**3 330**

micro COMPRESSOR+ ultra QUIET+ easy INSTALL+

### 1. Installation:

<b>S</b> standard: on the wall	0
<b>M</b> mobile stand, 4 wheels, white color (RAL 9010), 230V EURO plug, 2m	235
<b>F</b> fixed floor stand, color: white RAL9010 - matching the color of the main unit, 230V EURO plug, 2m	260
<b>P</b> through-the-wall INDOOR INSTALLATION (fiberglass cover with TTW ducts set and removable aluminum grills, metal ducts galvanized, insulated)	595
<b>T Premium</b> through-the-wall INDOOR INSTALLATION (metal powder coated cover, wall ducts, removable grills, metal ducts galvanized, insulated)	1 390
<b>E</b> through-the-wall OUTDOOR INSTALLATION (40mm TTW external aluminum and rubber insulation, winter module, condensate tray defrost, -15°C), fiberglass cover	1 350

### 2. Control:

<b>S</b> standard: built-in digital touch controller with WiFi and RS-485 (Modbus)	0
<b>E</b> remote wireless humidistat & thermostat DRY EASY 300 + built-in touch controller with WiFi and RS-485 (Modbus)	345
<b>W6</b> remote wired humidistat EBERLE HYG6001+built-in touch controller	120
<b>W7</b> remote wired humidistat & thermostat EBERLE HYG7001+built-in touch controller	140

### 3. Air temperature:

<b>S</b> standard: +9°C...+42°C	0
---------------------------------	---

### 4. Air heating:

<b>S</b> standard: without LPHW (Low Pressure Hot Water)	0
<b>H</b> LPHW, 3.5 kW, without regulation	228
<b>V</b> LPHW, 3.5 kW, with solenoid valve, fully automated regulation	442
<b>E</b> Electrical heating 2 kW	490

### 5. LPHW connection:

<b>S</b> standard: N/A (without LPHW)	0
<b>B</b> from the back	0
<b>R</b> from right	0
<b>L</b> from left	0

### 6. micro LIGHT+

<b>S</b> standard: without Pool Security microLIGHT+	0
<b>L</b> Pool Security microLIGHT+	140

### 7. Air filter:

<b>S</b> standard: without air filter	0
<b>F</b> Air filter (for model with wall or mobile stand installation: 1-S/M/F option)	52
<b>C</b> Air filter grid (for model with TTW installation: 1-P/E option) (G3 class)	52

### 8. Fresh air supply:

<b>S</b> standard: without fresh air supply	0
<b>F</b> adapter, Ø 100 mm, 50 mm length, galvanized	35

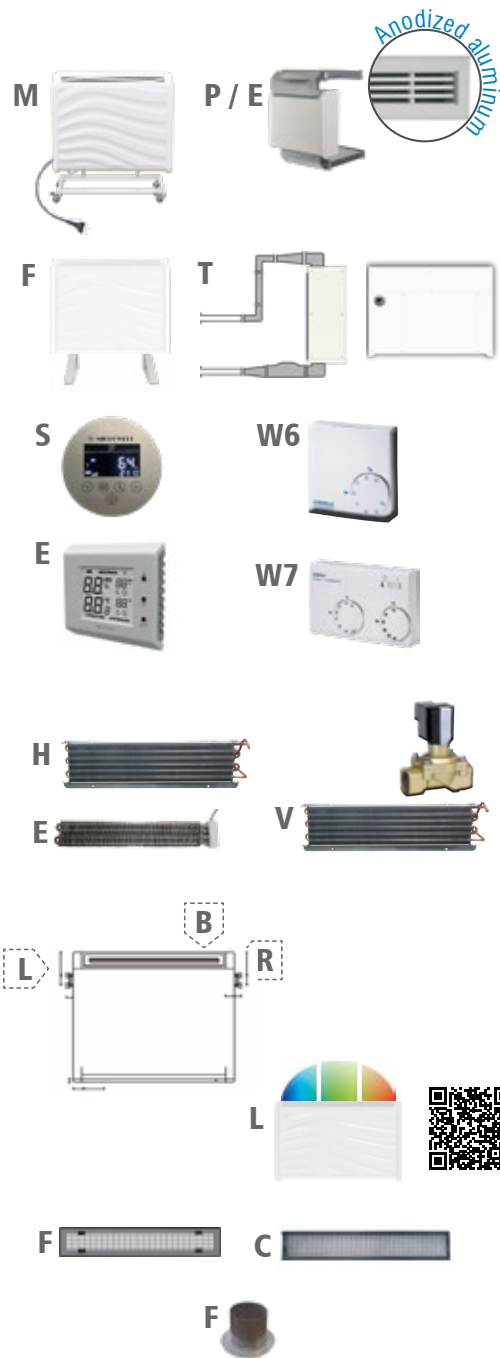

EURO PALETTE packed, FUMIGATED  
**17.50€/1pc** (Depending on the model it is possible to pack more units on EUP (2-6pcs).)

48 l  
45 m<sup>2</sup>

# DRY 400 METAL / ALU | DRY 400 SILVER

Cover	Cover	Extraction rate	Air flow
DRY 400 METAL / ALU	DRY 400 SILVER	(30°C/60% RH - 30°C/80% RH)	
aluminium	stainless steel	48-78 l/24hrs	600 m <sup>3</sup> /hour



DRY 400M

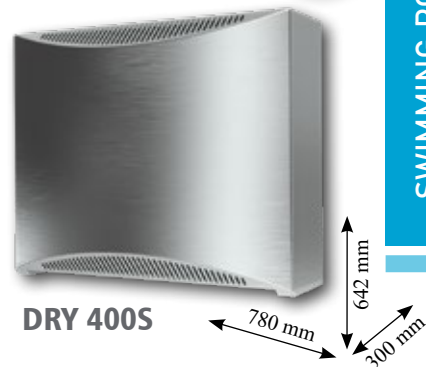

DRY 400S

SWIMMING POOL DEHUMIDIFIERS

DRY 400M - 1. - 2. - 3. - 4. - 5. - 6. - 7. - 8. - 9.

DRY 400S - - 2. - 3. - 4. - 5. - 6. - 7. - 8. - 9.



Wi-Fi included

100% corrosion free

Basic equipment:	Model:	Price EXW w/o VAT / EUR/
Dehumidifier, wall console, user's manual installation layout, fixation screws, step inverter fan	<b>DRY 400 METAL / ALU</b>	<b>3 830</b>
<b>FREE 3 YEARS WARRANTY</b>	<b>DRY 400 SILVER</b>	<b>4 850</b>

micro COMPRESSOR+ ultra QUIET+ easy INSTALL+

## 1. Color options:

<b>W</b> standard: white (RAL9010)	0
<b>S</b> silver color „Silver grey“ - Tiger	85
<b>C</b> color selection according to your preference (RAL code) - 200+ colors	price on demand

## 2. Installation:

<b>S</b> standard: on the wall	0
<b>M</b> mobile stand, 4 wheels, color: silver 'Tiger', white (RAL 9010), 230V EURO plug, 2m	235
<b>F</b> fixed floor stand, color: black RAL9005, 230V EURO plug, 2m	260

## 3. Control:

<b>S</b> standard: built-in digital touch controller with WiFi and RS-485 (Modbus)	0
<b>E</b> remote wireless humidistat & thermostat DRY EASY 300 + built-in touch controller with WiFi and RS-485 (Modbus)	345
<b>W6</b> remote wired humidistat EBERLE HYG6001+built-in touch controller	120
<b>W7</b> remote wired humidistat & thermostat EBERLE HYG7001+built-in touch controller	140

## 4. Air temperature:

<b>S</b> standard: +9°C...+36°C	0
---------------------------------	---

## 5. Air heating:

<b>S</b> standard: without LPHW (Low Pressure Hot Water)	0
<b>H</b> LPHW, 3.5 kW, without regulation	228
<b>V</b> LPHW, 3.5 kW, with solenoid valve, fully automated regulation	442
<b>E</b> Electrical heating 2 kW	490

## 6. LPHW connection:

<b>S</b> standard: N/A (without LPHW)	0
<b>B</b> from the back	0
<b>R</b> from right	0
<b>L</b> from left	0

## 7. microLIGHT+

<b>S</b> standard: without Pool Security microLIGHT+	0
<b>L</b> Pool Security microLIGHT+	140

## 8. Air filter:

<b>S</b> standard: without air filter	0
<b>F</b> Air filter	52

## 9. Fresh air supply:

<b>S</b> standard: without fresh air supply	0
<b>F</b> adapter, Ø 100 mm, 50 mm length, galvanized	35



EURO PALETTE packed, FUMIGATED  
**17.50€/1pc** (Depending on the model it is possible to pack more units on EUP (2-6pcs).)



v. 01/2025

**MICROWELL**



# Dehumidification, ventilation and heating with one device

- Dehumidify
- Heat
- Fresh air, Ventilation

**3 in 1**



**MICROWELL**

LEADING EUROPEAN SWIMMING POOL DEHUMIDIFIERS MANUFACTURER

[www.microwell.eu](http://www.microwell.eu)

# Customized solution

Microwell provides tailored on-demand service for individual solutions for general prices similar to those of serial production

- Demand your tailor made solution & design by Microwell
- Select from 25 basic models
- Add from 50+ available accessories
- Create right-to-fit unit for your needs

If you did not find what you expected elsewhere, we may have a solution.





66 l  
60 m<sup>2</sup>

## DRY 500 WAVE

Cover	Extraction rate (30°C/60% RH - 35°C/95% RH)	Air flow
plastic (acryl)	66-132 l/24hrs	800 m <sup>3</sup> /hour



### DRY 500W - 1. - 2. - 3. - 4. - 5. - 6. - 7. - 8.

#### Basic equipment:

Dehumidifier, wall console, user's manual, installation layout, fixation screws, step inverter fan

micro COMPRESSOR+ ultra QUIET+ easy INSTALL+



Price EXW  
w/o VAT /EUR/

**4 090**

#### 1. Installation:

<b>S</b> standard: on the wall	0
<b>M</b> mobile stand, 4 wheels, white color (RAL 9010), 230V EURO plug, 2m	265
<b>F</b> fixed floor stand, color: white RAL9010 - matching the color of the main unit, 230V EURO plug, 2m	280
<b>P</b> through-the-wall INDOOR INSTALLATION (fiberglass cover with TTW ducts set and removable aluminum grills, metal ducts galvanized, insulated)	740
<b>T Premium</b> through-the-wall INDOOR INSTALLATION (metal powder coated cover, wall ducts, removable grills, metal ducts galvanized, insulated)	1 590
<b>E</b> through-the-wall OUTDOOR INSTALLATION (40mm TTW external aluminum and rubber insulation, winter module, condensate tray defrost, -15°C), fiberglass cover	1 480

#### 2. Control:

<b>S</b> standard: built-in digital touch controller with WiFi and RS-485 (Modbus)	0
<b>E</b> remote wireless humidistat & thermostat DRY EASY 300 + built-in touch controller with WiFi and RS-485 (Modbus)	345
<b>W6</b> remote wired humidistat EBERLE HYG6001+built-in touch controller	120
<b>W7</b> remote wired humidistat & thermostat EBERLE HYG7001+built-in touch controller	140

#### 3. Air temperature:

<b>S</b> standard: +9°C...+36°C	0
<b>V</b> +9°C...+42°C (high temperature set)	259
<b>F</b> +5°C...+35°C (low temperature set with 4-way valve hot gas defrost)	385

#### 4. Air heating:

<b>S</b> standard: without LPHW (Low Pressure Hot Water)	0
<b>H</b> LPHW, 5 kW, without regulation	228
<b>V</b> LPHW, 5 kW, with solenoid valve, fully automated regulation	442
<b>E</b> Electrical heating 2 kW	490

#### 5. LPHW connection:

<b>S</b> standard: N/A (without LPHW)	0
<b>B</b> from the back	0
<b>R</b> from right	0
<b>L</b> from left	0

#### 6. micro LIGHT+

<b>S</b> standard: without Pool Security microLIGHT+	0
<b>L</b> Pool Security microLIGHT+	140

#### 7. Air filter:

<b>S</b> standard: without air filter	0
<b>F</b> Air filter (for model with wall or mobile stand installation: 1-S/M/F option)	54
<b>C</b> Air filter grid (for model with TTW installation: 1-P/E option) (G3 class)	67

#### 8. Fresh air supply:

<b>S</b> standard: without fresh air supply	0
<b>F</b> adapter, Ø 100 mm, 50 mm length, galvanized	35

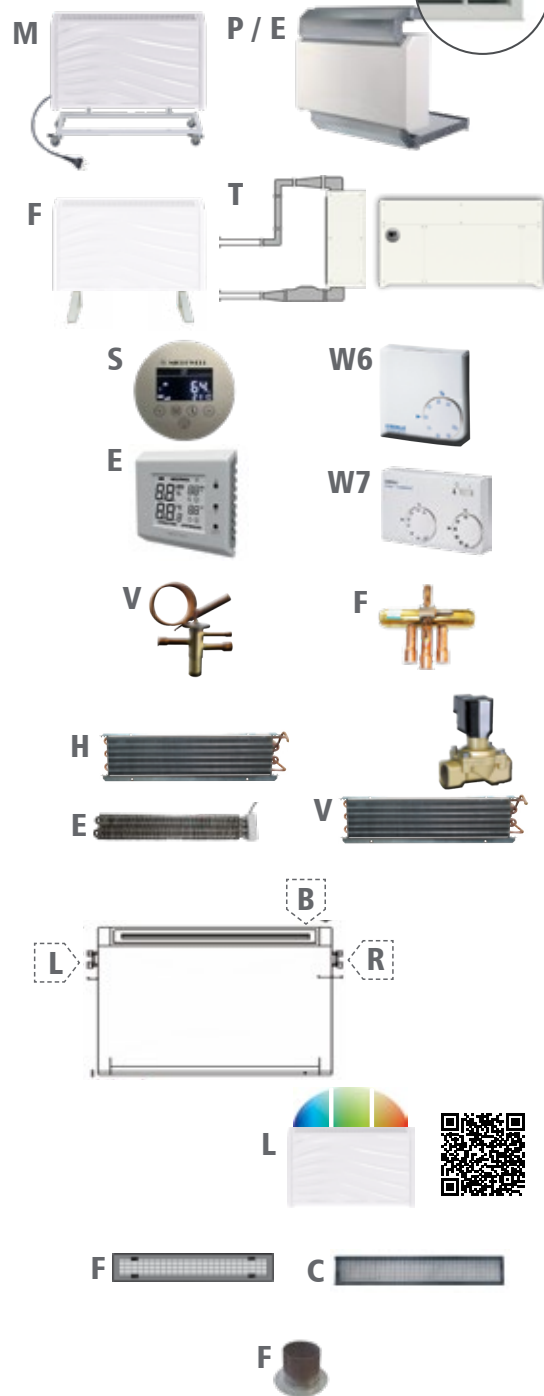

EURO PALETTE packed, FUMIGATED  
**17.50€/1pc** (Depending on the model it is possible to pack more units on EUP (2-6pcs).)

66 l  
60 m<sup>2</sup>

# DRY 500 METAL / ALU | DRY 500 SILVER

Cover	Cover	Extraction rate	Air flow
DRY 500 METAL / ALU	DRY 500 SILVER	(30°C/60% RH - 35°C/95% RH)	
aluminium	stainless steel	66-132 l/24hrs	800 m <sup>3</sup> /hour



DRY 500M



DRY 500S

SWIMMING POOL DEHUMIDIFIERS

DRY 500M - 1. - 2. - 3. - 4. - 5. - 6. - 7. - 8. - 9.

DRY 500S - 1. - 2. - 3. - 4. - 5. - 6. - 7. - 8. - 9.



100%  
corrosion free

Basic equipment:	Model:	Price EXW w/o VAT /EUR/
Dehumidifier, wall console, user's manual, installation layout, fixation screws, step inverter fan	<b>DRY 500 METAL / ALU</b>	<b>4 870</b>
<b>micro COMPRESSOR+</b> <b>ultra QUIET+</b> <b>easy INSTALL+</b>	<b>DRY 500 SILVER</b>	<b>6 200</b>



## 1. Color options:

<b>W</b> standard: white (RAL9010)	0
<b>S</b> silver color ‚Silver grey’ - Tiger	100
<b>C</b> color selection according to your preference (RAL code) - 200+ colors	price on demand

## 2. Installation:

<b>S</b> standard: on the wall	0
<b>M</b> mobile stand, 4 wheels, color: silver ‚Tiger’, white (RAL 9010), 230V EURO plug, 2m	265
<b>F</b> fixed floor stand, color: black RAL9005, 230V EURO plug, 2m	280

## 3. Control:

<b>S</b> standard: built-in digital touch controller with WiFi and RS-485 (Modbus)	0
<b>E</b> remote wireless humidistat & thermostat DRY EASY 300 + built-in touch controller with WiFi and RS-485 (Modbus)	345
<b>W6</b> remote wired humidistat EBERLE HYG6001+built-in touch controller	120
<b>W7</b> remote wired humidistat & thermostat EBERLE HYG7001+built-in touch controller	140

## 4. Air temperature:

<b>S</b> standard: +9°C...+35°C	0
<b>V</b> +9°C...+42°C (high temperature set)	259
<b>F</b> +5°C...+35°C (low temperature set with 4-way valve hot gas defrost)	385

## 5. Air heating:

<b>S</b> standard: without LPHW (Low Pressure Hot Water)	0
<b>H</b> LPHW, 5 kW, without regulation	246
<b>V</b> LPHW, 5 kW, with solenoid valve, fully automated regulation	458
<b>E</b> Electrical heating 2 kW	490

## 6. LPHW connection:

<b>S</b> standard: N/A (without LPHW)	0
<b>B</b> from the back	0
<b>R</b> from right	0
<b>L</b> from left	0

## 7. micro LIGHT+

<b>S</b> standard: without Pool Security microLIGHT+	0
<b>L</b> Pool Security microLIGHT+	140

## 8. Air filter:

<b>S</b> standard: without air filter	0
<b>F</b> Air filter	54

## 9. Fresh air supply:

<b>S</b> standard: without fresh air supply	0
<b>F</b> adapter, Ø 100 mm, 50 mm length, galvanized	35

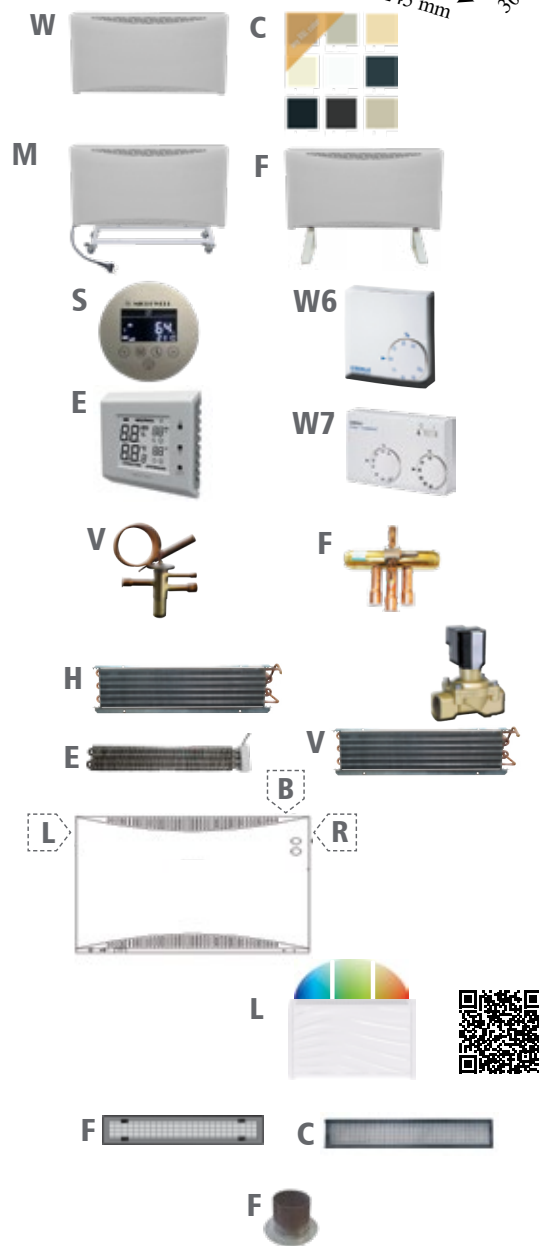

EURO PALETTE packed, FUMIGATED  
**17.50€/1pc** (Depending on the model it is possible to pack more units on EUP (2-6pcs).)



v. 01/2025





90l  
90 m<sup>2</sup>

## DRY 800 WAVE

120l  
120 m<sup>2</sup>

## DRY 1200 WAVE

Cover	Extraction rate (30°C/60% RH - 35°C/95% RH)	Air flow	Extraction rate (30°C/60% RH - 35°C/95% RH)	Air flow
plastic (acryl) white color	90-180 l/24hrs	1100 m <sup>3</sup> /hour	120-240 l/24hrs	1200 m <sup>3</sup> /hour

**DRY 800W** - 1. - 2. - 3. - 4. - 5. - 6. - 7. - 8.

**DRY 1200W** - 1. - 2. - 3. - 4. - 5. - 6. - 7. - 8.

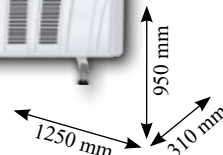

### Basic equipment:

### Model:

Price EXW  
w/o VAT /EUR/

Dehumidifier, floor feet, user's manual, step inverter fan I

**DRY 800 WAVE**

**5 460**

micro COMPRESSOR+ ultra QUIET+ easy INSTALL+



**DRY 1200 WAVE**

**5 880**

### 1. Installation:

<b>S</b> standard: on the floor	0
<b>M</b> on the wall (floor feet + wall console)	135

### 2. Control:

<b>S</b> standard: built-in digital touch controller with WiFi and RS-485 (Modbus)	0
<b>E</b> remote wireless humidistat & thermostat DRY EASY 300 + built-in touch controller with WiFi and RS-485 (Modbus)	345
<b>W6</b> remote wired humidistat EBERLE HYG6001+built-in touch controller	120
<b>W7</b> remote wired humidistat & thermostat EBERLE HYG7001+built-in touch controller	140

### 3. Air temperature:

<b>S</b> standard: +9°C...+36°C	0
<b>B</b> +9°C...+42°C (high temperature set)	270

### 4. Air heating:

<b>S</b> standard: without LPHW (Low Pressure Hot Water)	0
<b>H</b> LPHW, 7 kW, without regulation	345
<b>V</b> LPHW, 7 kW, with solenoid valve, fully automated regulation	590
<b>E</b> Electrical heating 2.5 kW	570

### 5. LPHW connection:

<b>S</b> standard: N/A (without LPHW)	0
<b>B</b> from the back	0
<b>R</b> from right	0

### 6. micro LIGHT+

<b>S</b> standard: without Pool Security microLIGHT+	0
<b>L</b> Pool Security microLIGHT+	140

### 7. Air filter:

<b>S</b> standard: without air filter	0
<b>F</b> Air filter (for model with wall or mobile stand installation: 1-S/M option)	54

### 8. Fresh air supply:

<b>S</b> standard: without fresh air supply	0
<b>F</b> adapter, Ø 100 mm, 50 mm length, galvanized	35

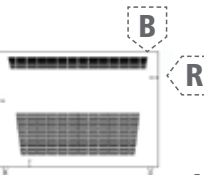

EURO PALETTE packed, FUMIGATED

**17.50€/1pc**

(Depending on the model it is possible to pack more units on EUP (2-6pcs).)

90l  
90 m<sup>2</sup>

## DRY 800 METAL / ORIENT

120l  
120 m<sup>2</sup>

## DRY 1200 METAL / ORIENT

NEW  
DESIGN

Cover	Extraction rate (30°C/60% RH - 35°C/95% RH)	Air flow	Extraction rate (30°C/60% RH - 35°C/95% RH)	Air flow
metal	90-180 l/24hrs	1100 m <sup>3</sup> /hour	120-240 l/24hrs	1200 m <sup>3</sup> /hour

**DRY 800M** - 1. - 2. - 3. - 4. - 5. - 6. - 7. - 8. - 9.   
**DRY 1200M** - 1. - 2. - 3. - 4. - 5. - 6. - 7. - 8. - 9.   
 Wi-Fi included

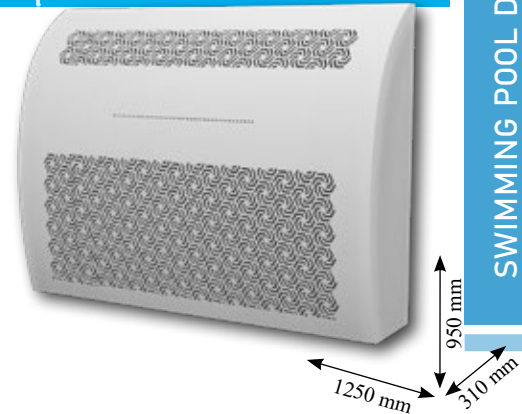

SWIMMING POOL DEHUMIDIFIERS

Basic equipment:	Model:	Price EXW w/o VAT /EUR/
Dehumidifier, floor feet, user's manual, step inverter fan, <b>microlight</b> 	<b>DRY 800 METAL / ORIENT</b>	<b>5 980</b>
<b>micro COMPRESSOR</b> + <b>ultra QUIET</b> + <b>easy INSTALL</b> +	<b>DRY 1200 METAL / ORIENT</b>	<b>6 500</b>

1. Color options:		
<b>W</b> standard: white (RAL9010)		0
<b>S</b> silver color „Silver grey“ - Tiger		130
<b>C</b> color selection according to your preference (RAL code) - <b>200+ colors</b>		price on demand

2. Installation:		
<b>S</b> standard: on the floor		0
<b>M</b> on the wall (floor feet + wall console)		135
<b>P</b> through-the-wall INDOOR INSTALLATION (main chassis cover from galvanized metal powder coated RAL9010 with AIR IN from the back, AIR OUT to the back/to the top, including the through-the-wall ducts set and removable grills, insulated from the inside)		325
<b>E</b> through-the-wall OUTDOOR INSTALLATION (40mm TTW external aluminum and rubber insulation, winter module, condensate tray defrost, -15°C)		895

3. Control:		
<b>S</b> standard: built-in digital touch controller with WiFi and RS-485 (Modbus)		0
<b>E</b> remote wireless humidistat & thermostat DRY EASY 300 + built-in touch controller with WiFi and RS-485 (Modbus)		345
<b>W6</b> remote wired humidistat EBERLE HYG6001+built-in touch controller		120
<b>W7</b> remote wired humidistat & thermostat EBERLE HYG7001+built-in touch controller		140

4. Air temperature:		
<b>S</b> standard: +9°C...+36°C		0
<b>B</b> +9°C...+42°C (high temperature set)		270

5. Air heating:		
<b>S</b> standard: without LPHW (Low Pressure Hot Water)		0
<b>H</b> LPHW, 7 kW, without regulation		345
<b>V</b> LPHW, 7 kW, with solenoid valve, fully automated regulation		590
<b>E</b> Electrical heating 2.5 kW		570

6. LPHW connection:		
<b>S</b> standard: N/A (without LPHW)		0
<b>B</b> from the back		0
<b>R</b> from right		0

7. <b>micro LIGHT</b> +		
<b>L</b> Pool Security <b>microLIGHT</b> + included		0

8. Air filter:		
<b>S</b> standard: without air filter		0
<b>F</b> Air filter (for model with wall or floor installation: 2-S/M option)		54
<b>C</b> Air filter grid (for model with TTW installation: 2-P/E option) (G3 class)		67

9. Fresh air supply:		
<b>S</b> standard: without fresh air supply		0
<b>F</b> adapter, Ø 100 mm, 50 mm length, galvanized		35

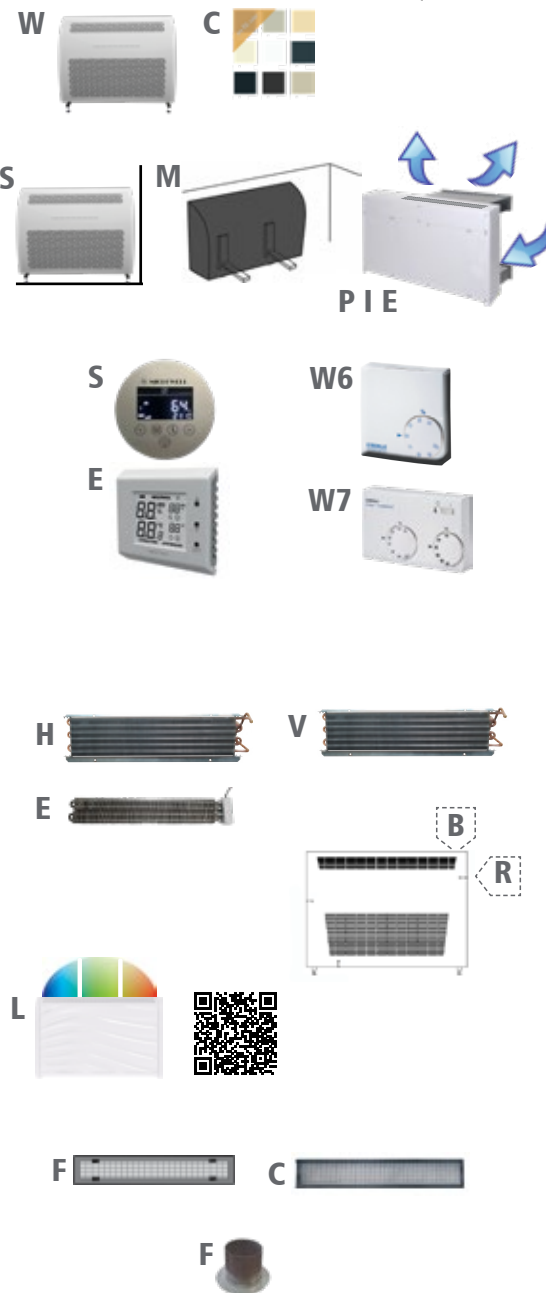

EURO PALETTE packed, FUIGATED  
**17.50€/1pc** (Depending on the model it is possible to pack more units on EUP (2-6pcs).)

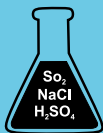

## DRY Salt+ Sulphur+

Applicable  
to all models  
of dehumidi-  
fiers

**8x**  
more  
reliable  
use

**3%**  
wt/wt  
Maximum salt  
content

**30**  
kg/m<sup>3</sup>  
Maximum salt  
content

Models:	Price EXW /* w/o VAT /EUR/ 1-5 pcs	Price EXW /* w/o VAT /EUR/ 6-14 pcs	Price EXW /* w/o VAT /EUR/ 15 pcs+
DRY 300 Salt+ Sulphur+	1 380	1180	880
DRY 400 Salt+ Sulphur+	1 380	1180	880
DRY 500 Salt+ Sulphur+	1 560	1 360	1 060
DRY 800 Salt+ Sulphur+	1 740	1 540	1 240
DRY 1200 Salt+	1 740	1 540	1 240

**/\* Brutto Price List price.**  
Distributor rebates apply.

### Basic description:

Special treatment to withstand high concentrations of salt, sulphur and chlorine. Designed for natural salt/sulphur water spa, salt caves or alternatives with natural water spring spa that contains high concentrations of salt or sulphur. This special treatment can be applied also to high chlorine concentration pools where it provides higher resistance thereby longer livelihood of the device. Treatment is also designed to avoid formation of sulphuric acid (H<sub>2</sub>SO<sub>4</sub>).

- Natural spa
- Salt caves
- Chlorine
- Sulphur

- Extra zinc
- Extra LCE Epoxy coating
- Extra powder coating enamel at 180°
- Extra brex insulation





Special treatment to withstand high concentration  
of **SALT, SULPHUR and CHLORINE.**

Suitable for natural salt/sulfur  
water spa, salt caves and  
pools with high concentration  
of salt, sulfur or chlorine.



**DRY Salt+ Sulphur+**

**PROLONGS  
LIVELIHOOD OF  
YOUR DEHUMIDIFIER**

IN EXTREME CONDITIONS



Applicable to  
all models of  
pool dehu-  
midifiers

**8x  
more  
reliable use**



32 l  
30 m<sup>2</sup>

## DRY 300 DUCT

Cover	Extraction rate (30°C/60% RH - 35°C/95% RH)	Air flow
metal	32-63 l/24hrs	500 m <sup>3</sup> /hour, 200 Pa



### DRY 300D - 1. - 2. - 3. - 4. - 5. - 6. - 7.

#### Basic equipment:

Dehumidifier, wall console, fixation screws, user's manual, installation layout

**Price EXW**  
w/o VAT /EUR/

**3 770**

micro COMPRESSOR+

micro CONTROL+



#### 1. Installation:

<b>S</b> standard - INDOOR: on the wall	0
<b>E</b> through-the-wall OUTDOOR INSTALLATION (40mm TTW external aluminum and rubber insulation, winter module, condensate tray defrost, -15°C)	535

#### 2. Control:

<b>S</b> standard: built-in digital touch controller with WiFi and RS-485 (Modbus)	0
<b>E</b> remote wireless humidistat & thermostat DRY EASY 300 + built-in touch controller with WiFi and RS-485 (Modbus)	345
<b>W6</b> remote wired humidistat EBERLE HYG6001+built-in touch controller	120
<b>W7</b> remote wired humidistat & thermostat EBERLE HYG7001+built-in touch controller	140

#### 3. Air temperature:

<b>S</b> standard: +9°C...+36°C	0
<b>V</b> +9°C...+42°C (high temperature set)	259
<b>F</b> +5°C...+35°C (low temperature set with 4-way valve hot gas defrost)	385

#### 4. Air heating:

<b>S</b> standard: without LPHW (Low Pressure Hot Water)	0
<b>H</b> LPHW, 3.5 kW, without regulation	228
<b>V</b> LPHW, 3.5 kW, with solenoid valve, fully automated regulation	442
<b>E</b> Electrical heating, 2 kW	490

#### 5. LPHW connection:

<b>S</b> standard: N/A (without LPHW)	0
<b>B</b> from the back	0
<b>R</b> from right	0

#### 6. Air filter console:

<b>S</b> standard: without air filter console	0
<b>C</b> Air filter console 5C, with removable cartouche (G3 - class)	150

#### 7. Air ducting connection:

<b>S1</b> Air inlet from bottom	0
<b>S2</b> Air outlet from the top	0
<b>F1</b> Air inlet from the front	80
<b>F2</b> Air outlet from the front	80

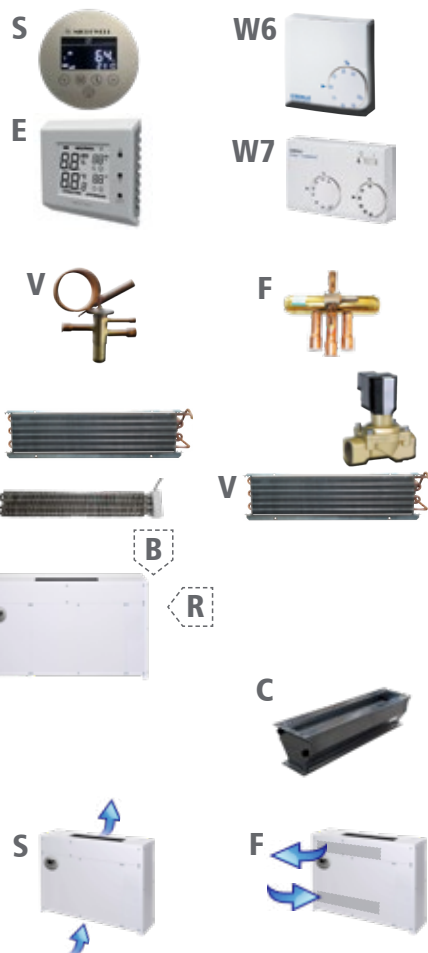

EURO PALETTE packed, FUMIGATED  
**17.50€/1pc** (Depending on the model it is possible to pack more units on EUP (2-6pcs).)

Find more **ACCESSORIES**  
on pages 61-75.

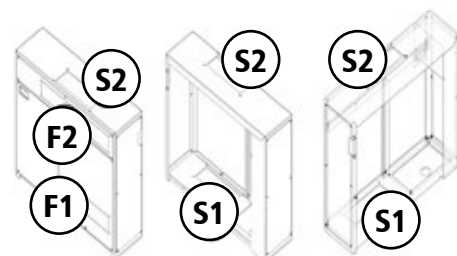

43 l  
40 m<sup>2</sup>

# DRY 400 DUCT

Cover	Extraction rate (30°C/60% RH - 35°C/95% RH)	Air flow
metal	43-78 l/24hrs	500 m <sup>3</sup> /hour, 200 Pa



## DRY 400D - 1. - 2. - 3. - 4. - 5. - 6. - 7.

**Basic equipment:** Price EXW w/o VAT /EUR/

Dehumidifier, wall console, fixation screws, user's manual, installation layout

**4 180**

1. Installation:	
<b>S</b> standard - INDOOR: on the wall	0
<b>E</b> through-the-wall OUTDOOR INSTALLATION (40mm TTW external aluminum and rubber insulation, winter module, condensate tray defrost, -15°C)	535
2. Control:	
<b>S</b> standard: built-in digital touch controller with WiFi and RS-485 (Modbus)	0
<b>E</b> remote wireless humidistat & thermostat DRY EASY 300 + built-in touch controller with WiFi and RS-485 (Modbus)	345
<b>W6</b> remote wired humidistat EBERLE HYG6001+built-in touch controller	120
<b>W7</b> remote wired humidistat & thermostat EBERLE HYG7001+built-in touch controller	140
3. Air temperature:	
<b>S</b> standard: +9°C...+42°C	0
4. Air heating:	
<b>S</b> standard: without LPHW (Low Pressure Hot Water)	0
<b>H</b> LPHW, 3.5 kW, without regulation	228
<b>V</b> LPHW, 3.5 kW, with solenoid valve, fully automated regulation	442
<b>E</b> Electrical heating, 2 kW	490
5. LPHW connection:	
<b>S</b> standard: N/A (without LPHW)	0
<b>B</b> from the back	0
<b>R</b> from right	0
6. Air filter console:	
<b>S</b> standard: without air filter console	0
<b>C</b> Air filter console 5C, with removable cartouche (G3 - class)	150
7. Air ducting connection:	
<b>S1</b> Air inlet from bottom	0
<b>S2</b> Air outlet from the top	0
<b>F1</b> Air inlet from the front	80
<b>F2</b> Air outlet from the front	80

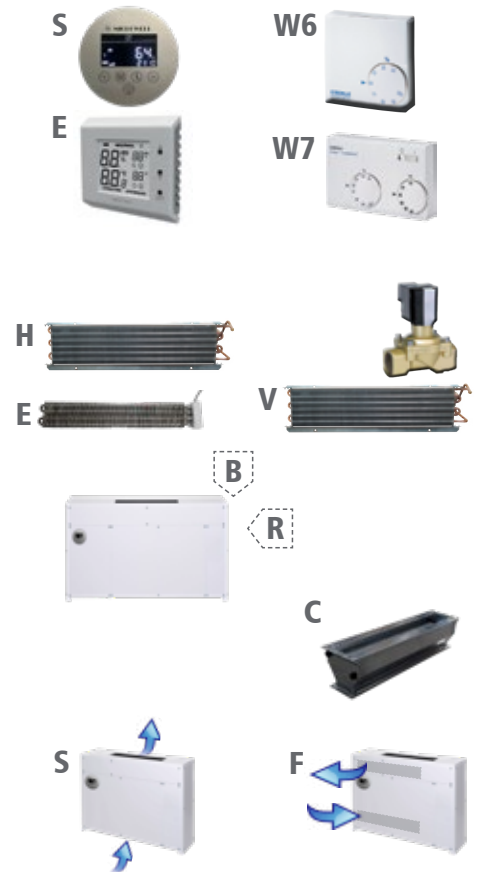

**EURO PALETTE** packed, FUMIGATED  
**17.50€/1pc** (Depending on the model it is possible to pack more units on EUP (2-6pcs).)

52 l  
50 m<sup>2</sup>

## DRY 500 DUCT

Cover	Extraction rate (30°C/60% RH - 35°C/95% RH)	Air flow
metal	52-132 l/24hrs	1000 m <sup>3</sup> /hour, 200 Pa

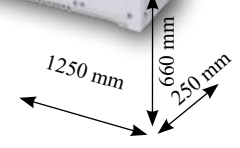

### DRY 500D - 1. - 2. - 3. - 4. - 5. - 6. - 7.

**Basic equipment:** Price EXW w/o VAT /EUR/

Dehumidifier, wall console, fixation screws, user's manual, installation layout

micro COMPRESSOR+
micro CONTROL+
FREE 3 YEARS WARRANTY
Wi-Fi included
**4 900**

#### 1. Installation:

S standard - INDOOR: on the wall	0
E through-the-wall OUTDOOR INSTALLATION (40mm TTW external aluminum and rubber insulation, winter module, condensate tray defrost, -15°C)	586

#### 2. Control:

S standard: built-in digital touch controller with WiFi and RS-485 (Modbus)	0
E remote wireless humidistat & thermostat DRY EASY 300 + built-in touch controller with WiFi and RS-485 (Modbus)	345
W6 remote wired humidistat EBERLE HYG6001+built-in touch controller	120
W7 remote wired humidistat & thermostat EBERLE HYG7001+built-in touch controller	140

#### 3. Air temperature:

S standard: +9°C...+36°C	0
V +9°C...+42°C (high temperature set)	259
F +5°C...+35°C (low temperature set with 4-way valve hot gas defrost)	385

#### 4. Air heating:

S standard: without LPHW (Low Pressure Hot Water)	0
H LPHW, 5 kW, without regulation	228
V LPHW, 5 kW, with solenoid valve, fully automated regulation	442
E Electrical heating, 2 kW	490

#### 5. LPHW connection:

S standard: N/A (without LPHW)	0
B from the back	0
R from right	0

#### 6. Air filter console:

S standard: without air filter console	0
C Air filter console 5C, with removable cartouche (G3 - class)	170

#### 7. Air ducting connection:

S1 Air inlet from bottom	0
S2 Air outlet from the top	0
F1 Air inlet from the front	80
F2 Air outlet from the front	80

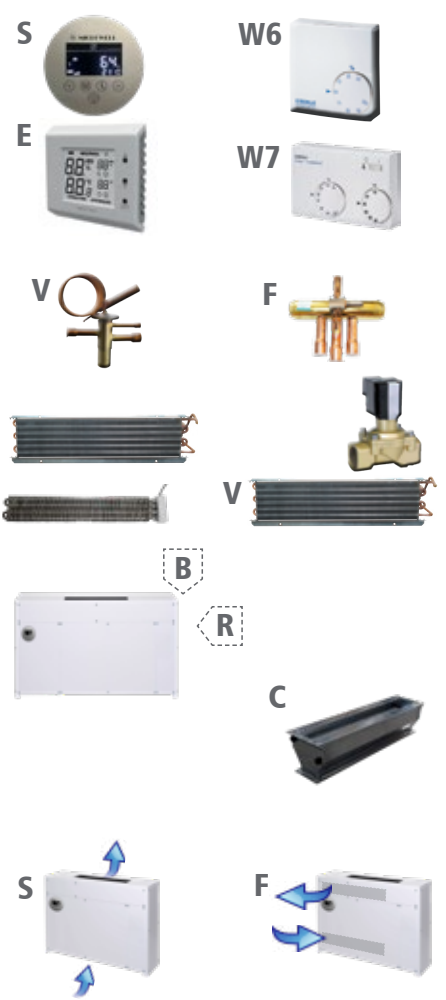

EURO PALETTE packed, FUMIGATED  
**17.50€/1pc** (Depending on the model it is possible to pack more units on EUP (2-6pcs).)

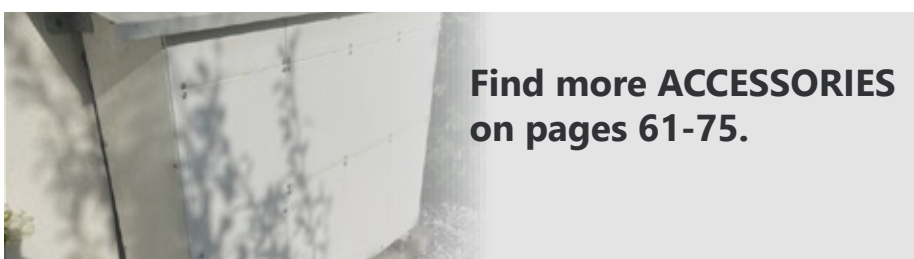

Find more ACCESSORIES on pages 61-75.

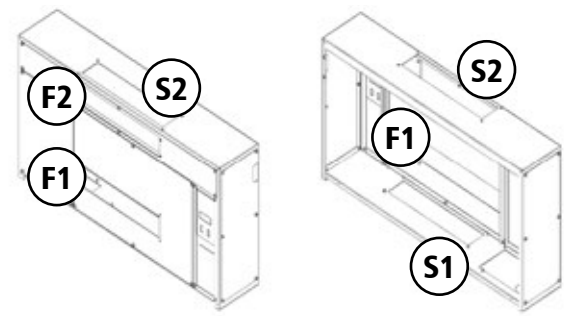

88l 80 m <sup>2</sup>	<b>DRY 800 DUCT</b>	112l 110 m <sup>2</sup>	<b>DRY 1200 DUCT</b>
Cover	Extraction rate (30°C/60% RH - 35°C/95% RH)	Air flow	
metal	88-180 l/24hrs	1100 m <sup>3</sup> /hour, 170 Pa	
			Extraction rate (30°C/60% RH - 35°C/95% RH)
			Air flow
			112-240 l/24hrs
			1200 m <sup>3</sup> /hour, 145 Pa

**DRY 800D** - [1.] - [2.] - [3.] - [4.] - [5.] - [6.] - [7.]

**DRY 1200D** - [1.] - [2.] - [3.] - [4.] - [5.] - [6.] - [7.] Wi-Fi included

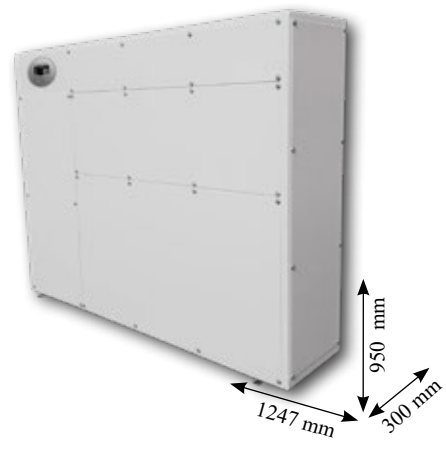

Basic equipment:	Model:	Price EXW w/o VAT /EUR/
Dehumidifier, floor feet, fixation screws, user's manual, installation layout	<b>DRY 800 DUCT</b>	<b>6 600</b>
	<b>DRY 1200 DUCT</b>	<b>7 080</b>



1. Installation:		
<b>S</b> standard: INDOOR on the floor		0
<b>M</b> on the wall (floor feet + wall console)		235
<b>E</b> through-the-wall OUTDOOR INSTALLATION (40mm TTW external aluminum and rubber insulation, winter module, condensate tray defrost, -15°C)		660
2. Control:		
<b>S</b> standard: built-in digital touch controller with WiFi and RS-485 (Modbus)		0
<b>E</b> remote wireless humidistat & thermostat DRY EASY 300 + built-in touch controller with WiFi and RS-485 (Modbus)		345
<b>W6</b> remote wired humidistat EBERLE HYG6001+built-in touch controller		120
<b>W7</b> remote wired humidistat & thermostat EBERLE HYG7001+built-in touch controller		140
3. Air temperature		
<b>S</b> standard: +9°C...+36°C		0
<b>B</b> +9°C...+42°C (high temperature set)		285
4. Air heating:		
<b>S</b> standard: without LPHW (Low Pressure Hot Water)		0
<b>H</b> LPHW, 7 kW, without regulation		345
<b>V</b> LPHW, 7 kW, with solenoid valve, fully automated regulation		590
<b>E</b> Electrical heating 2.5 kW		570
5. LPHW connection:		
<b>S</b> standard: N/A (without LPHW)		0
<b>B</b> from the back		0
<b>R</b> from right		0
6. Air filter console:		
<b>S</b> standard: without air filter console		0
<b>C</b> Air filter console 5C, with removable cartouche (G3 - class)		250
7. Air ducting connection:		
A1 Air inlet from the back		0
A2 Air outlet from the back		0
B1 Air inlet from the front		80
B2 Air outlet from the front		80
C1 Air inlet from the bottom		80
C2 Air outlet from the top		0

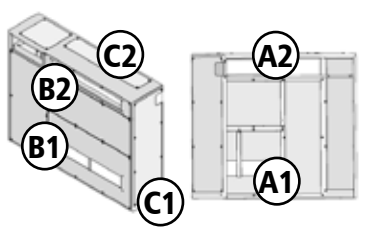
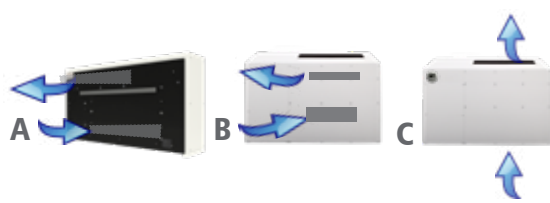
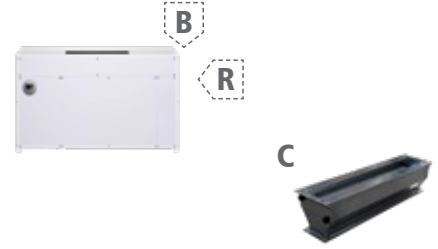
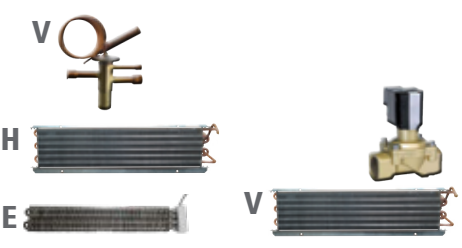

**EURO PALETTE** packed, FUMIGATED  
**17.50€/1pc** (Depending on the model it is possible to pack more units on EUP (2-6pcs).)



67 l 60 m <sup>2</sup> SIREN Eco mono			134 l 120 m <sup>2</sup> SIREN Eco due		
Cover	Extraction rate (30°C/60% RH - 35°C/95% RH)	Air flow	Extraction rate (30°C/60% RH - 35°C/95% RH)	Air flow	
plastic (acryl) white color	67-130 l/24hrs	1000 m <sup>3</sup> / hour	134-260 l/24hrs	2000 m <sup>3</sup> /hour	

**SIREN Eco mono** - 1. - 2. - 3. - 4. - 5.

**SIREN Eco due** - 1. - 2. - 3. - 4. - 5.

Basic equipment:	Model:	Price EXW w/o VAT /EUR/
ceiling unit, compressor unit, remote control, wall consoles for compressor unit, ceiling lifting mechanism, Bluetooth speaker, LED light, user's manual	<b>SIREN Eco mono</b>	<b>8 450</b>
2x ceiling unit, compressor unit, remote control, wall consoles for compressor unit, ceiling lifting mechanism, Bluetooth speaker, LED light, user's manual	<b>SIREN Eco due</b>	<b>13 900</b>

micro LIGHT +
micro ENERGY +
micro SAFETY +
FREE 3 YEARS WARRANTY
R32

1. Ceiling unit installation:		
<b>S</b> concrete ceiling		0
<b>B</b> wooden beam		0
2. Cable length:		
<b>S</b> 10m		0
<b>M</b> 20m		70
<b>L</b> 30m		90
3. Copper pipes:		
<b>S</b> standard: without copper pipes		0
<b>A</b> Insulated copper pipes D10 (3/8" x 1)+D12 (1/2" x 1) - 50m package /Rebate not applicable. This is the final purchase price./		510
4. Condensate pump:		
<b>S</b> standard: built-in condensate pump, vertical discharge 1~8m, horizontal discharge 21~0m		0
<b>E</b> external condensate pump, vertical suction up to 3m, horizontal suction up to 10m, vertical discharge 1~8m, horizontal discharge 21~0m		40
<b>A</b> additional condensate pump Sauermann – condensing, with tank 2l, 500l/h, max. 5m		75
5. Condensate hose:		
<b>S</b> standard: with 1m condensate hose 6mm internal / 9mm external flexible		0
<b>A</b> Condensate hose #106008 6mm internal / 9mm external flexible		0.95

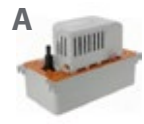
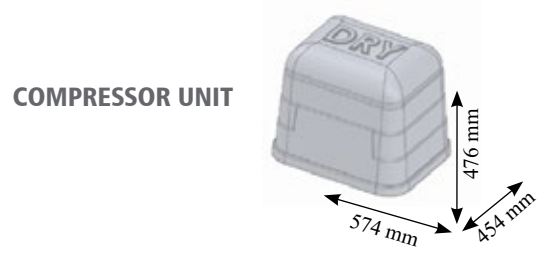

**EURO PALETTE packed, FUMIGATED**  
**17.50€/1pc** (Depending on the model it is possible to pack more units on EUP (2-6pcs).)



# Perfect dehumidification without limits

MICROWELL SIREN ECO is the ultimate superstar, the first ceiling swimming pool dehumidifier in the world. Combining all what Microwell technology has to offer, SIREN ECO is an intelligent and visually captivating solution of paramount performance, setting a new tide in the industry.

As the first round ceiling dehumidifier it is constructed as dual split unit, capable of all round and thorough humidity extraction.

**SPLIT  
system**

**Wireless  
control**

DEHUMIDIFIER



microLIGHT+



LOUDSPEAKER



LED LAMP



# Siren Eco

up to 120 m<sup>2</sup> pool surface

94l 90 m <sup>2</sup>	<b>DRY 800 HORIZON</b>	127l 120 m <sup>2</sup>	<b>DRY 1200 HORIZON</b>
Cover	Extraction rate (30°C/60% RH - 30°C/80% RH)	Air flow	Extraction rate (30°C/60% RH - 30°C/80% RH)
metal - RAL 9010 white	94-141 l/24hrs	1150 m <sup>3</sup> /hour	127-194 l/24hrs 1800 m <sup>3</sup> /hour

**DRY 800 HORIZON** - 1. - 2. - 3. - 4. - 5. - 6. - 7.

**DRY 1200 HORIZON** - 1. - 2. - 3. - 4. - 5. - 6. - 7.



Basic equipment:	Model:	Price EXW w/o VAT /EUR/
Dehumidifier, user's manual	<b>DRY 800 HORIZON</b>	<b>6 950</b>
	<b>DRY 1200 HORIZON</b>	<b>7 450</b>

1. Installation:		
S ceiling-mounted (on threaded rods M8)		0
F floor-mounted (floor console)		120
W wall-mounted console		150

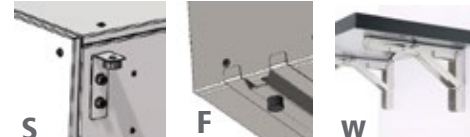

2. Exhaust direction (pool supply):		
H horizontal 600x200mm		0
D downward 600x200mm		0
U upward 600x200mm		0

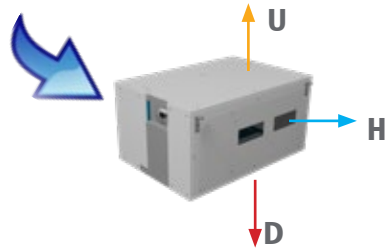

3. Control:		
S standard: built-in digital touch controller with WiFi and RS-485 (Modbus)		0
E remote wireless humidistat & thermostat DRY EASY 300 + built-in touch controller with WiFi and RS-485 (Modbus)		345
W6 remote wired humidistat EBERLE HYG6001+built-in touch controller		120
W7 remote wired humidistat & thermostat EBERLE HYG7001+built-in touch controller		140
R External touch controller (WIFI, RS-485 Modbus), 10m cable		90

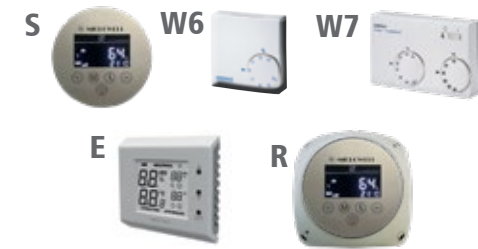

4. Air temperature:		
S standard: +9°C...+36°C		0
B +9°C...+42°C (high temperature set)		270

5. External supplementary air heating (on exhaust)*:		
S without		0
HC1 hot water heater ILU 315 max output 14.5 kW (90/70°C, 0.18 l/s, 5.9 kPa), on exhaust circular pipe dia 315 mm / length 200 mm, width 420 mm, height 355 mm, water connection diameter d 1/2" + solenoid 2-way valve d 1/2", fully automatic regulation		846
HC2 hot water heater ILU 400 max output 24.5 kW (90/70°C, 0.3 l/s, 12.3 kPa), on exhaust circular pipe dia 400 mm / length 200 mm, width 495 mm, height 430 mm, water connection diameter d 1/2" + solenoid 2-way valve d 1/2", fully automatic regulation		956
EC electrical heater dia 315-400mm max output 9.0 kW		upon request



\*Note: It is necessary to insert approximately 1m of air ducting between the fan and the heater to avoid fan motor overheating.

6. External filter cartridge (on suction):		
S standard: without air filter		0
C external filter cartridge with flat filter on the intake rectangular pipe 800 x 400 mm / length 200-250 mm (G3 class)		280



7. Air ducting adapters:		
S Without adapters		0
R1 rounded adapters for dia 315 mm / length 400 mm on suction and exhaust (2 pcs), axis		170
R2 rounded adapters for dia 400 mm / length 400 mm on suction and exhaust (2 pcs), axis		180
O other - rectangular, square, double, axis/non-axis		upon request

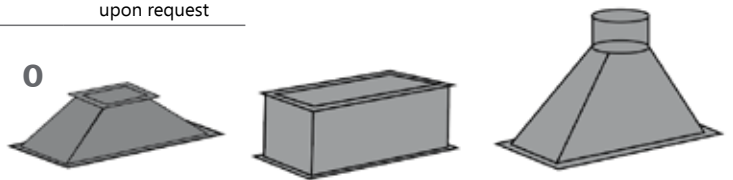



# HORIZON DRY

New concept of concealed and ducted swimming pool dehumidifiers

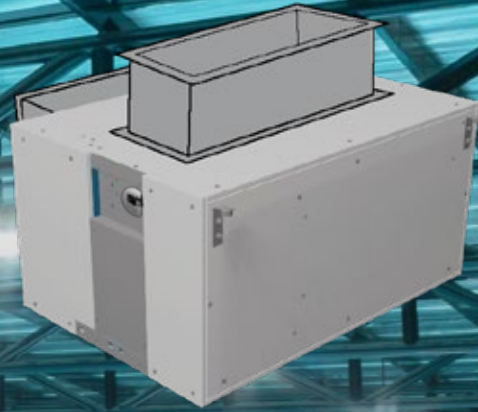

3 air directions  
for connection available

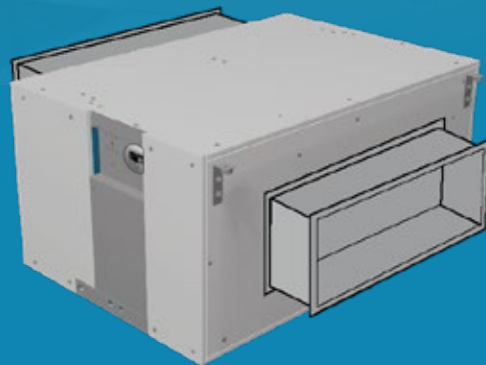
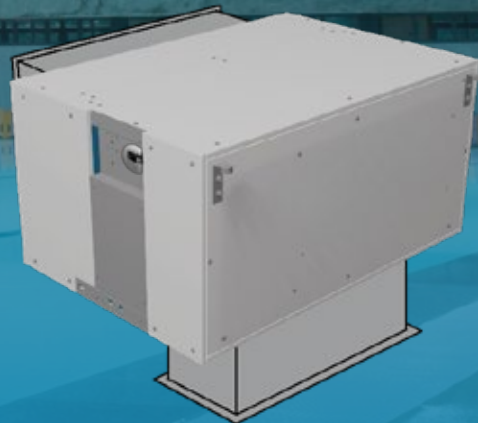



22 l 90 m <sup>3</sup> /* <b>DRY 300 GALLERY</b>			38 l 135 m <sup>3</sup> /* <b>DRY 400 GALLERY</b>	
Cover	Extraction rate (25°C, 50%RH)	Air flow	Extraction rate (25°C, 50%RH)	Air flow
wooden wardrobe construction	22 l/24hrs	550 m <sup>3</sup> /h	38 l/hrs	600 m <sup>3</sup> /h



**DRY 300G** - **1.** - **2.** - **3.**

**DRY 400G** - **1.** - **2.** - **3.**

Basic equipment:	Model:	Price EXW w/o VAT /EUR/
Fully mobile dehumidifier, 20 liter condensation tank, mobile cart, water tank drainage, float switch, user's manual  micro <b>COMPRESSOR+</b>	<b>DRY 300 GALLERY</b>	<b>3 390</b>
	<b>DRY 400 GALLERY</b>	<b>3 590</b>

1. Control:		
S standard: built-in digital touch controller with WiFi and RS-485 (Modbus)		0
2. Air temperature:		
S standard: +9°C...+36°C		0
F +5°C...+36°C (with 4-way valve hot gas defrost) low temperature set		246
3. Air filter:		
S standard: without air filter		0
F Air filter		56

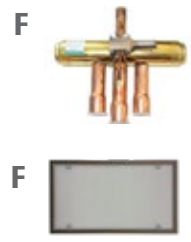

Basic equipment includes:

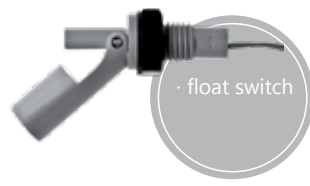

 **EURO PALETTE** packed, FUMIGATED  
**17.50€/1pc** (Depending on the model it is possible to pack more units on EUP (2-6pcs).)

Warranty period: 5 years compressor + titanium exchanger | 2 years other components



**Suitable for  
small exhibition spaces**

Picture is illustratory.

40 l day	T40   TE40		90 l day	T90   TE9		120 l day	T120   TE120	
Cover	Operating range	Nominal air delivery	Operating range	Nominal air delivery	Operating range	Nominal air delivery		
metal	0°C - 35°C	500 m³/hour	0°C - 35°C	1100 m³/hour	0°C - 35°C	1500 m³/hour		



ENERGY CONSUMPTION  
from **650W**



/\* Final prices. Discount does not apply on these items.

Basic equipment:	Price EXW /* w/o VAT /EUR/
Fully mobile dehumidifier, user's manual, EU plug, on-off Designed for drying up buildings, new construction sites, warehouses, as well as non-heated and flooded buildings with high level of humidity.	
<b>easy INSTALL+</b>	
<b>T40</b>	<b>1 300</b>
<b>TE40</b>	<b>1 400</b>
with Electrical heater, 2 kW	
<b>T90</b>	<b>1 800</b>
<b>TE90</b>	<b>1 990</b>
with Electrical heater, 2 kW	
<b>T120</b>	<b>2 100</b>
<b>TE120</b>	<b>2 250</b>
with Electrical heater, 2 kW	

Additional equipment:	Price EXW /* w/o VAT /EUR/
<b>A</b> UK plug conversion	20
<b>B</b> Float switch	90
<b>C</b> External hygostat	100
<b>D</b> 20l bucket with mobile base (4 wheels)	85

T40 | TE40

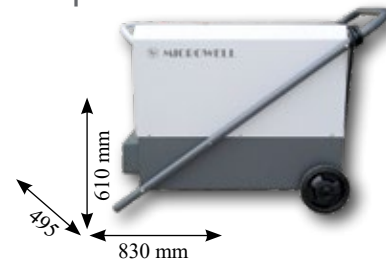

T90 | TE90

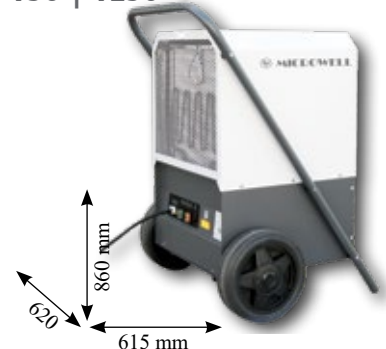

T120 | TE120

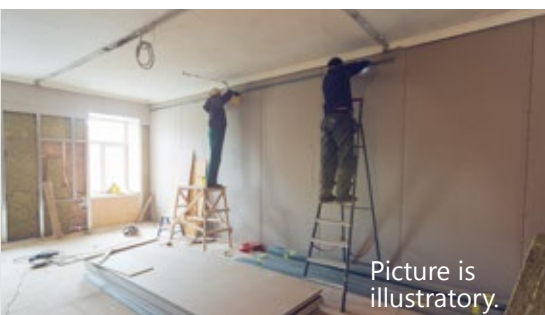
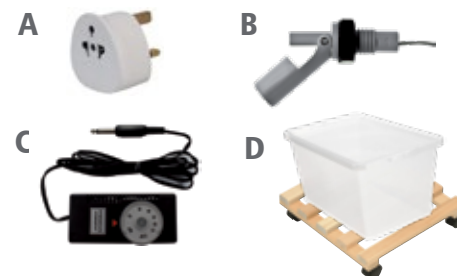

Picture is illustratory.

**Suitable for construction sites, buildings, rooms after reconstruction**

**EURO PALETTE** packed, FUMIGATED  
**17.50€/1pc** (Depending on the model it is possible to pack more units on EUP (2-6pcs).)



# Heat pumps

ON-OFF & INVERTER models

Available in COMPACT & SPLIT versions

For seasonal, or full year using

**Variety of models to fit every pool.**

**Excellent craftsmanship and experience.**

MICROWELL HP range of swimming pool heat pumps are operating on the principle of renewable energy, designed for continuous and stable production of water heating or cooling.

Their exceptional efficiency, low environment impact and low costs are the result of superior technology, putting them at the industry's forefront.

# MICROWELL HP Line 2025

	Model	Version	Pool capacity (cover/ no cover) m <sup>3</sup>	(A27/W27, RH80%)			Air temperature (WINTER modification) °C	Cooling capacity (A35/W28) (HP BLACK -A43/W35) kW	Water flow m <sup>3</sup> /h	Power supply V AC/ Ph	El. connection / protection mm <sup>2</sup>	Titanium Grade & Surface /*	Acoustic pressure level (1m/10m) dB(A)	Dimensions netto (W x H x D) condensing unit mm	Weight netto kg
				Heat capacity kW	Power cons. kW	COP									
FULL YEAR - OR SEASONAL	HP 2300 INVENTOR (3f)		80 / 60	23	3.59	6.4	-5...+40 (-15...+40) (-5...+60)	20.1	8-10	400/3	5x25/ C10A	Gr 1 ASTM265 0.95 m <sup>2</sup>	56/38	942x1550x360 (942x1250x360)	118
	HP 2800 INVENTOR (3f)		120 / 80	28.4	4.44	6.4	-5...+40 (-15...+40) (-5...+60)	25.0	8-12	400/3	5x25/ C10A	Gr 1 ASTM265 1.2 m <sup>2</sup>	56/38	942x1550x360 (942x1250x360)	120
SEASONAL - INVERTER	HP 900 BLACK Inverter		40 / 15-30	9.0	0.2~1.6	17.2 ~5.8	-7...+43	2.7	2.7	230/1	3x25/ C16A	Gr 1 ASTM265 0.4 m <sup>2</sup>	49/40	932x609x377	43
	HP 1100 BLACK Inverter		45 / 25-35	11.5	0.2~1.9	17.2 ~5.9	-7...+43	3.5	3.3	230/1	3x25/ C16A	Gr 1 ASTM265 0.5 m <sup>2</sup>	50/41	932x609x377	44
	HP 1500 BLACK Inverter		65 / 35-50	15.0	0.3~2.7	17.2 ~5.7	-7...+43	5.4	4.4	230/1	3x25/ C16A	Gr 1 ASTM265 0.6 m <sup>2</sup>	53/43	1015x766x427	61
FULL YEAR - INVERTER	HP 1100 SILVER Inverter Pro		65 / 30	11.7	0.2-1.6	24.1 - 1.9	-20...+43	4.5	5.0	230/1	3x25/ C16A	Gr 1 ASTM265 0.52 m <sup>2</sup>	45.5/26.5	1000x460x656	60
	HP 1500 SILVER Inverter Pro		80 / 40	15.6	0.22 - 2.12	24.2 - 1.89	-20...+43	6.7	6.6	230/1	3x25/ C16A	Gr 1 ASTM265 0.7 m <sup>2</sup>	47/28	1055x490x750	70
	HP 1800 SILVER Inverter Pro		95 / 45	18.3	0.28 - 2.57	24.2 - 2.0	-20...+43	7.5	7.8	230/1	3x4/ C20A	Gr 1 ASTM265 0.80 m <sup>2</sup>	38.5/28.5	1160x530x800	77
	HP 2100 SILVER Inverter Pro		105 / 50	21.4	0.29 - 3.00	24.1 - 1.95	-20...+43	9.5	9.2	230/1	3x4/ C20A	Gr 1 ASTM265 0.9 m <sup>2</sup>	50/30	1160x530x800	87
	HP 2800 SILVER Inverter Pro (3f)		135 / 60	28.5	0.35 - 3.95	24.1 - 1.93	-20...+43	11.9	12.2	400/3	5x25/ C10A	Gr 1 ASTM265 1.0 m <sup>2</sup>	50.5/31	1030x550x1200	114
FULL YEAR PREMIUM	HP 2400 PREMIUM (3f)		80 / 60	24.4	3.51	6.9	-15...+40 (-5...+60)	21.7	8-10	400/3	5x25/ C10A	Gr 1 ASTM265 1.2 m <sup>2</sup>	56/38	942x1550x360 (942x1250x360)	118
	HP 3000 PREMIUM (3f)		120 / 80	30.1	4.34	6.9	-15...+40 (-5...+60)	26.8	8-12	400/3	5x25/ C10A	Gr 1 ASTM265 1.4 m <sup>2</sup>	56/38	942x1550x360 (942x1250x360)	120
COMMERCIAL - INVERTER / ON-OFF	MAX 50-450 fixed speed On-Off T1-T3	COMPACT	125-2000	50 - 450	8.5 - 76.7	5.7	-10...+43 (0...+55)	26 - 250	12 - 108	400/3 50 Hz or 60 Hz	-	-	58/80	-	-
	iMAX 50-450 variable speed Inverter T1-T3					6.2 - 16.1									

/\* Notes: The manufacturer reserves the right to change the parameters without notice.

**Grade 1 titanium** is the first of commercially available pure titanium grades. It is the softest and most ductile type of titanium material. It possesses the greatest **formability** and **excellent corrosion resistance**. Grade 1 titanium will ensure long happy life of your heat pump and will also prevent possible transport damage due to its **high impact toughness**.





# INVISIBLE HEAT PUMP FOR WHIRLPOOL

ENJOY YOUR BELOVED WHIRLPOOL BATH  
WITHOUT WORRYING ABOUT ENERGY BILL



**-15°C** **+40°C**  
**AMBIENT** **WATER**



# INVISIBLE SET UP SPLIT

WATER HEAT EXCHANGER  
INSIDE JACUZZI CHASSIS

HEAT PUMP UP TO  
30 METERS AWAY

30 M



There is no additional noise, vibration or visual disturbance since the split heat pump can be placed as far as 30 meters away from the jacuzzi.



An intuitive control panel with full integration into the jacuzzi's control is possible with RS-485, DRY contact or WLAN.



Split heat pump's water unit can be fully integrated inside the jacuzzi. It is thus fully invisible and also protected against frost.





# MAX

## SWIMMING POOL HEAT PUMP FOR AQUAPARKS AND BIG HOTEL POOLS

Commercial Microwell MAX air source swimming pool heat pump is designed for heavy duty heating and cooling pool jobs in 4 season environment.

Available capacities: 50kW to 450kW in single machine.

### 3 available makes:

1. 4-season Europe  $-10^{\circ}\text{C} \sim +43^{\circ}\text{C}$  50Hz
2. Tropical Middle East  $0^{\circ}\text{C} \sim +55^{\circ}\text{C}$  50Hz
3. Tropical Middle East  $0^{\circ}\text{C} \sim +55^{\circ}\text{C}$  60Hz



**15 years of  
experience**

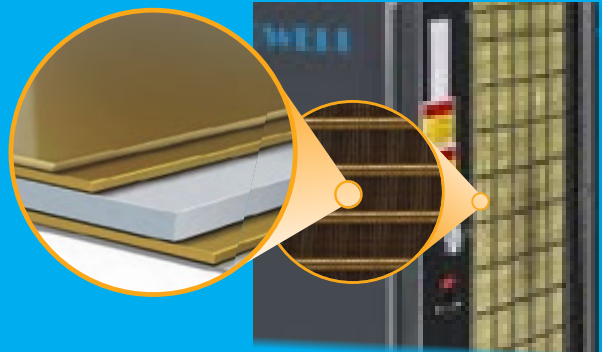

**GoldFin**

epoxid aluminium 100%  
corrosion free



# SILVER INVERTER PRO

## whole year swimming pool heat pump



The new generation of year-round swimming pool heat pumps from Microwell with an enhanced defrosting system

- Engineered for silence: 36dB
- Remarkably efficient: COP 24.2
- Premium Craftsmanship: Brushed anodized Aluminum
- Unique insulation and defrost down to -20°C



23 kW 80 m <sup>3</sup>				28.4 kW 120 m <sup>3</sup>		
<b>HP 2300 INVENTOR Compact</b>				<b>HP 2800 INVENTOR Compact</b>		
Cover	COP	Heating output	Cooling output	COP	Heating output	Cooling output
metal	5.8 - 7.6 (A26 W26)*	20.9-27.2 kW (A26 W26)*	20.1 kW (A30 W35)*	5.8 - 7.6 (A26 W26)*	25.8-33.5 kW (A26 W26)*	25 kW (A30 W35)*

<b>SEASON</b> -5~40°C	<b>FULL YEAR</b> -15~40°C	<b>TROPICAL</b> -5~60°C
--------------------------	------------------------------	----------------------------



**HP 2300 INVENTOR C** - 1. - 2. - 3. - 4.



**HP 2800 INVENTOR C** - 1. - 2. - 3. - 4.



Basic equipment:	Model:	Price EXW w/o VAT /EUR/
Heat pump (including GoldFin, Panasonic/Sanyo compressor, 4-way valve hot gas defrost, EEV), user's manual	<b>HP 2300 INVENTOR C</b>	<b>4 850</b>
micro COMPRESSOR + micro ECONOMY + anti VIBRATION + anti FREEZE + ultra QUIET +	<b>HP 2800 INVENTOR C</b>	<b>5 350</b>

1. Full year modification:		
<b>S</b> standard: without WINTER module (-5°C...+40°C)		0
<b>W</b> with WINTER module (-15°C...+40°C)		350
2. Tropical / Chiller adjustment:		
<b>S</b> standard: without		0
<b>T</b> TROPICAL KIT (extra compressor cooling) ... up to 60°C ambient air		270
<b>C</b> CHILLER (extra thermal insulation) ... to allow water cooling to +5°C		215
3. Control display placement:		
<b>S</b> standard: control display placed on the heat pump		0
<b>W</b> wall installation (out of the heat pump), includes wall plaster box, 30m cable		40
4. Wi-Fi:		
<b>S</b> standard: without Wi-Fi		0
<b>W</b> with Wi-Fi		49
Equipment:		
<b>Protection cover:</b> Heavy duty waterproof UV resistant cover /Rebate does not apply on this item. This is the actual purchase price./		290
<b>Rubber base installation block</b> 400mm - black, carrying capacity 200kg. Set includes 2pcs. Price is stated for 1pc /No. 6065/		set 26.40
Self-regulating heating cable:		
230V/4m/64W, Euro plug 2m, IP68 /Rebate does not apply on this item. This is the actual purchase price./		28.50



ALLOWING HEAT PUMP USAGE IN AMBIENT AIR FROM +42°C TO +60°C.



**EXCHANGER EQUIPPED WITH TITANIUM**

EURO PALLETTE packed, FUMIGATED  
**17.50€/1pc** (Depending on the model it is possible to pack more units on EUP (2-6pcs).)

**Smart Life**

REGULATION OVER Wi-Fi ANDROID and IOS APP available for free

28.4kW  
120 m<sup>3</sup>

# HP 2800 INVENTOR Split

# Traditional excellence, built to last.

COP	Heating output	Cooling output
5.8 - 7.6 (A26 W26)*	25.8-33.5 kW (A26 W26)*	25 kW (A30 W35)*

<b>SEASON</b> -5~40°C	<b>FULL YEAR</b> -15~40°C	<b>TROPICAL</b> -5~60°C
--------------------------	------------------------------	----------------------------



## HP 2800 INVENTOR S - 1. - 2. - 3. - 4.



Basic equipment:	Model:	Price EXW w/o VAT /EUR/
Air unit (including GoldFin, Panasonic/Sanyo compressor, 4-way valve hot gas defrost, EEV), Hydro kit - water titanium exchanger (installation in technical room), user's manual		
<span>micro COMPRESSOR +</span> <span>micro ECONOMY +</span> <span>anti VIBRATION +</span> <span>anti FREEZE +</span> <span>ultra QUIET +</span>	<b>HP 2800 INVENTOR S</b>	<b>5 350</b>



SWIMMING POOL HEAT PUMPS - ON-OFF

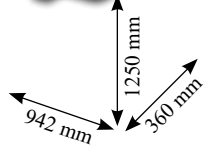

Hydro kit



S



W



Wi-Fi modul



Protection cover

1. Control display placement:		
<b>S</b> standard: digital display placed on outside unit (air unit)		0
<b>W</b> wall installation (out of the heat pump), includes wall plaster box, 30m cable		30
2. Wi-Fi:		
<b>S</b> standard: without Wi-Fi		0
<b>W</b> with Wi-Fi		49
3. Full year modification:		
<b>S</b> standard: without WINTER module (-5°C...+40°C)		0
<b>W</b> with WINTER module (-15°C...+40°C)		350
4. Tropical / Chiller adjustment:		
<b>S</b> standard: without		0
<b>T</b> TROPICAL KIT (extra compressor cooling) ... up to 60°C ambient air		270
<b>C</b> CHILLER (extra thermal insulation) ... to allow water cooling to +5°C		215

Equipment:		
<b>Protection cover:</b> Heavy duty waterproof UV resistant cover		290



ALLOWING HEAT PUMP USAGE IN AMBIENT AIR FROM +42°C TO +60°C.

EXCHANGER EQUIPPED WITH **TITANIUM**

EURO PALLETTE packed, FUMIGATED **17.50€/1pc** (Depending on the model it is possible to pack more units on EUP (2-6pcs).)



# Solves 3 cases out of 5 remotely

## IOT SERVICE CONSOLE

- 24/7 online supervision system
- Real-time & historical data
- Fault advice & solution
- Remote control & parameter settings
- Complete technical analysis remotely
- Up to 90 days data storage

**SAVES MINIMUM  
1 SERVICE VISIT**





**PROTECTED  
DATA**

  
**WIFI  
CONTROL**

**ONLINE  
DIAGNOSTICS**

**24/7  
SUPERVISION**

<b>9kW</b> <b>30 m<sup>3</sup></b>				<b>11.5kW</b> <b>35 m<sup>3</sup></b>			
<b>HP 900 BLACK Inverter</b>				<b>HP 1100 BLACK Inverter</b>			
Cover	COP	Heating output	Cooling output	COP	Heating output	Cooling output	
ABS plastic, black	17.2 - 5.8 (A27W26)*	1.8 - 9.0 kW (A27W26)*	2.7 kW (A27W26)*	17.2 - 5.9 (A27W26)*	2.3 - 11.5 kW (A27W26)*	3.5 kW (A27W26)*	

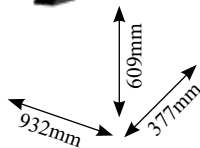

Rubber base installation block

**HP 900 BLACK Inverter Compact - 1.**

**HP 1100 BLACK Inverter Compact - 1.**

Basic equipment:	Model:	Price EXW w/o VAT /EUR/
Heat pump (including full stepless inverter DC compressor, brushless DC ventilator, GoldFin/, 4-way valve hot gas defrost), protection cover, user's manual, WIFI, IOT service console  anti VIBRATION + ultra QUIET + easy INSTALL +	<b>HP 900 BLACK Compact</b>	<b>1 850</b>
	<b>HP 1100 BLACK Compact</b>	<b>1 990</b>
<b>1. Control display placement:</b>		
<b>S</b> standard: control display placed on the heat pump		0
<b>R</b> remote regulation, 10m cable, touch controller		170
<b>Equipment:</b>		
<b>Rubber base installation block</b> 400mm - black, carrying capacity 200kg. Set includes 2pcs. Price is stated for 1pc /No. 6065/		set 26.40

**HP 900 BLACK Inverter Split - 1.**

**HP 1100 BLACK Inverter Split - 1.**



IOT APP CLOUD

Basic equipment:	Model:	Price EXW w/o VAT /EUR/
Heat pump (including full stepless inverter DC compressor, brushless DC ventilator, GoldFin/, 4-way valve hot gas defrost), protection cover, user's manual, WIFI, IOT service console  anti VIBRATION + ultra QUIET + easy INSTALL +	<b>HP 900 BLACK Split</b>	<b>2 190</b>
	<b>HP 1100 BLACK Split</b>	<b>2 390</b>
<b>1. Control display placement:</b>		
<b>S</b> standard: control display placed on the heat pump		0
<b>R</b> remote regulation, 10m cable, touch controller		170
<b>Equipment:</b>		
<b>Rubber base installation block</b> 400mm - black, carrying capacity 200kg. Set includes 2pcs. Price is stated for 1pc /No. 6065/		set 26.40



EURO PALLETTE packed, FUMIGATED  
**17.50€/1pc** (Depending on the model it is possible to pack more units on EUP (2-6pcs).)



15 kW  
50 m<sup>3</sup>

## HP 1500 BLACK Inverter

Cover	COP	Heating output	Cooling output
ABS plastic, black	17.2 - 5.7 (A27W26)*	2.9 - 15.4 kW (A27W26)*	5.4 kW (A27W26)*

SEASON  
-7~43°C



### HP 1500 BLACK Inverter Compact - 1.

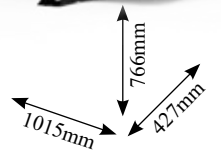

Rubber base installation block

Basic equipment:	Model	Price EXW w/o VAT /EUR/
------------------	-------	----------------------------

Heat pump (including full stepless inverter DC compressor, brushless DC ventilator, GoldFin/, 4-way valve hot gas defrost), protection cover, user's manual, WIFI, IOT service console

**HP 1500 BLACK Compact** **2 290**

anti VIBRATION + ultra QUIET + easy INSTALL +

1. Control display placement		
------------------------------	--	--

**S** standard: control display placed on the heat pump 0

**R** remote regulation, 10m cable, touch controller 170

Equipment:		
------------	--	--

**Rubber base installation block** 600mm - black, carrying capacity 200kg. Set includes 2pcs. Price is stated for 1pc /No. 6066/ set 34.80

### HP 1500 BLACK Inverter Split - 1.



Basic equipment:	Model:	Price EXW w/o VAT /EUR/
------------------	--------	----------------------------

Heat pump (including full stepless inverter DC compressor, brushless DC ventilator, GoldFin/, 4-way valve hot gas defrost), protection cover, user's manual, WIFI, IOT service console

**HP 1500 BLACK Split** **2 690**

anti VIBRATION + ultra QUIET + easy INSTALL +

1. Control display placement		
------------------------------	--	--

**S** standard: control display placed on the heat pump 0

**R** remote regulation, 10m cable, touch controller 170

Equipment:		
------------	--	--

**Rubber base installation block** 600mm - black, carrying capacity 200kg. Set includes 2pcs. Price is stated for 1pc /No. 6066/ set 34.80



IOT APP  
CLOUD



EURO PALLETTE packed, FUMIGATED  
**17.50€/1pc** (Depending on the model it is possible to pack more units on EUP (2-6pcs).)



v. 01/2025



11 kW  
40 m<sup>3</sup>

## HP 1100 SILVER Inverter Pro

Cover	COP	Heating output	Heating output BOOST	Cooling output
Aluminium	24.1 - 1.93	11.66 - 2.97 kW (A27 W26 RH80)*	12.2 kW (A27 W26 RH80)	4.5 kW (A35 W28)*



**FULL YEAR**  
-20~43°C



EXCHANGER  
EQUIPPED with  
0.52m<sup>3</sup>  
of TITANIUM



650mm  
1000mm  
460mm

### HP 1100 SILVER Inverter Pro Compact



**Basic equipment:**

Price EXW  
w/o VAT /EUR/

Heat pump /full stepless inverter DC compressor, brushless DC ventilator, GoldFin/, including 4-way valve hot gas defrost and EEV, condensate tray defrost, WINTER module, WiFi, Touch control, user's manual

**2 380**

anti VIBRATION + ultra QUIET + easy INSTALL +

**Equipment:**

**Protection cover:**

**Heavy duty** waterproof UV resistant cover\* 120

**Standard** heat pump seasonal cover 30

*\*/Rebate does not apply on this item. This is the actual purchase price./*

**Rubber base installation block** 600mm - black, carrying capacity 200kg. Set includes 2pcs. Price is stated for 1pc /No. 6066/ set 34.80



Protection cover



Rubber base installation block

### HP 1100 SILVER Inverter Pro Split - 1.



**Basic equipment:**

Price EXW  
w/o VAT /EUR/

Split heat pump - separate water unit with remote installation /full stepless inverter DC compressor, brushless DC ventilator, GoldFin/, including 4-way valve hot gas defrost and EEV, condensate tray defrost, WINTER module, WiFi, Touch control, user's manual

**2 690**

anti VIBRATION + ultra QUIET + easy INSTALL +

**1. Control display placement:**

**S** standard: control display placed on the heat pump 0

**E** external: wall installation (out of the heat pump), includes wall plaster box IP44, 10m cable, additional touch controller with Wi-Fi 190

**Equipment:**

**Rubber base installation block** 600mm - black, carrying capacity 200kg. Set includes 2pcs. Price is stated for 1pc /No. 6066/ set 34.80

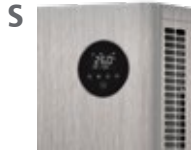

Rubber base installation block

**5 years WARRANTY**  
TITANIUM HEAT EXCHANGER  
COMPRESSOR

**2 years WARRANTY\***  
ON SPARE PARTS

REGULATION  
OVER Wi-Fi  
ANDROID  
and IOS APP  
available for free

Smart Life

EURO PALETTE packed, FUMIGATED  
**17.50€/1pc** (Depending on the model it is possible to pack more units on EUP (2-6pcs).)

15 kW  
60 m<sup>3</sup>

## HP 1500 SILVER Inverter Pro

Cover	COP	Heating output	Heating output BOOST	Cooling output
Aluminium	24.2 - 1.89	15.56 - 3.68 kW (A27 W26 RH80)*	16.3 kW (A27 W26 RH80)	6.7 kW (A35 W28)*



FULL YEAR  
-20~43°C



EXCHANGER  
EQUIPPED with  
0.72m<sup>2</sup>  
of TITANIUM

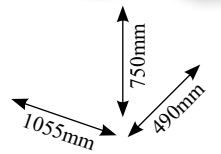

## HP 1500 SILVER Inverter Pro Compact



### Basic equipment:

Price EXW  
w/o VAT /EUR/

Heat pump /full stepless inverter DC compressor, brushless DC ventilator, GoldFin/, including 4-way valve hot gas defrost and EEV, condensate tray defrost, WINTER module, WiFi, Touch control, user's manual

2 750

anti VIBRATION + ultra QUIET + easy INSTALL +

### Equipment:

#### Protection cover:

Heavy duty waterproof UV resistant cover\*

140

Standard heat pump seasonal cover

30

*\*Rebate does not apply on this item. This is the actual purchase price./*

Rubber base installation block 600mm - black, carrying capacity 200kg. Set includes 2pcs. Price is stated for 1pc /No. 6066/

set 34.80



Protection cover



Rubber base installation block

## HP 1500 SILVER Inverter Pro Split - 1.



### Basic equipment:

Price EXW  
w/o VAT /EUR/

Split heat pump - separate water unit with remote installation /full stepless inverter DC compressor, brushless DC ventilator, GoldFin/, including 4-way valve hot gas defrost and EEV, condensate tray defrost, WINTER module, WiFi, Touch control, user's manual

3 080

anti VIBRATION + ultra QUIET + easy INSTALL +

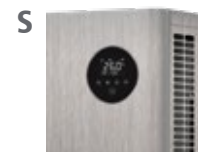

Rubber base installation block

### 1. Control display placement:

S standard: control display placed on the heat pump

0

E external: wall installation (out of the heat pump), includes wall plaster box IP44, 10m cable, additional touch controller with Wi-Fi

190

### Equipment:

Rubber base installation block 600mm - black, carrying capacity 200kg. Set includes 2pcs. Price is stated for 1pc /No. 6066/

set 34.80

★ 5 years WARRANTY  
TITANIUM HEAT EXCHANGER  
COMPRESSOR

★ 2 years WARRANTY★  
ON SPARE PARTS



EURO PALLETTE packed, FUMIGATED

17.50€/1pc

(Depending on the model it is possible to pack more units on EUP (2-6pcs).)



v. 01/2025





18 kW  
95 m<sup>3</sup>

## HP 1800 SILVER Inverter Pro

Cover	COP	Heating output	Heating output BOOST	Cooling output
Aluminium	24.2 - 2.0 (A26 W26)*	18.34 - 4.54 kW (A27 W26 RH80)*	19.3 kW (A27 W26 RH80)	7.5 kW (A35 W28)*



**FULL YEAR**  
-20~43°C



EXCHANGER  
EQUIPPED with  
0.8m<sup>2</sup>  
of TITANIUM



800mm  
1160mm  
530mm



Protection cover



Rubber base installation block

### HP 1800 SILVER Inverter Pro Compact



**Basic equipment:**

Heat pump /full stepless inverter DC compressor, brushless DC ventilator, GoldFin/, including 4-way valve hot gas defrost and EEV, condensate tray defrost, WINTER module, WiFi, Touch control, user's manual

Price EXW  
w/o VAT /EUR/

**3 280**

anti VIBRATION + ultra QUIET + easy INSTALL +

**Equipment:**

**Protection cover:**

**Heavy duty** waterproof UV resistant cover\* 180

**Standard** heat pump seasonal cover 30

*\*/Rebate does not apply on this item. This is the actual purchase price./*

**Rubber base installation block** 600mm - black, carrying capacity 200kg. Set includes 2pcs. Price is stated for 1pc /No. 6066/ set 34.80

### HP 1800 SILVER Inverter Pro Split - 1.



**Basic equipment:**

Split heat pump - separate water unit with remote installation /full stepless inverter DC compressor, brushless DC ventilator, GoldFin/, including 4-way valve hot gas defrost and EEV, condensate tray defrost, WINTER module, WiFi, Touch control, user's manual

Price EXW  
w/o VAT /EUR/

**3 650**

anti VIBRATION + ultra QUIET + easy INSTALL +

**1. Control display placement:**

**S** standard: control display placed on the heat pump 0

**E** external: wall installation (out of the heat pump), includes wall plaster box IP44, 10m cable, additional touch controller with Wi-Fi 190

**Equipment:**

**Rubber base installation block** 600mm - black, carrying capacity 200kg. Set includes 2pcs. Price is stated for 1pc /No. 6066/ set 34.80



Rubber base installation block

**5 years WARRANTY**  
TITANIUM HEAT EXCHANGER  
COMPRESSOR

**2 years WARRANTY\***  
ON SPARE PARTS

EURO PALETTE packed, FUMIGATED  
**17.50€/1pc** (Depending on the model it is possible to pack more units on EUP (2-6pcs).)

REGULATION OVER Wi-Fi  
ANDROID and IOS APP available for free

Smart Life



21 kW  
105 m<sup>3</sup>

## HP 2100 SILVER Inverter Pro

Cover	COP	Heating output	Heating output BOOST	Cooling output
Aluminium	24.1 - 1.95	21.40 - 4.78 kW (A27 W26 RH80)*	22.5 kW (A27 W26 RH80)	9.5 kW (A35 W28)*



**FULL YEAR**  
-20~43°C

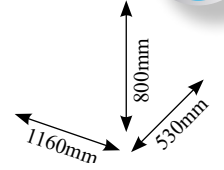

Protection cover



Rubber base installation block

### HP 2100 SILVER Inverter Pro Compact



#### Basic equipment:

Heat pump /full stepless inverter DC compressor, brushless DC ventilator, GoldFin/, including 4-way valve hot gas defrost and EEV, condensate tray defrost, WINTER module, WiFi, Touch control, user's manual

anti VIBRATION + ultra QUIET + easy INSTALL +

Price EXW  
w/o VAT /EUR/

4 290

#### Equipment:

##### Protection cover:

Heavy duty waterproof UV resistant cover\*

Standard heat pump seasonal cover

\*/Rebate does not apply on this item. This is the actual purchase price./

190

30

Rubber base installation block 600mm - black, carrying capacity 200kg. Set includes 2pcs. Price is stated for 1pc /No. 6066/

set 34.80

### HP 2100 SILVER Inverter Pro Split - 1.



#### Basic equipment:

Split heat pump - separate water unit with remote installation /full stepless inverter DC compressor, brushless DC ventilator, GoldFin/, including 4-way valve hot gas defrost and EEV, condensate tray defrost, WINTER module, WiFi, Touch control, user's manual

anti VIBRATION + ultra QUIET + easy INSTALL +

Price EXW  
w/o VAT /EUR/

4 720



S

E



Rubber base installation block

#### 1. Control display placement:

S standard: control display placed on the heat pump

0

E external: wall installation (out of the heat pump), includes wall plaster box IP44, 10m cable, additional touch controller with Wi-Fi

190

#### Equipment:

Rubber base installation block 600mm - black, carrying capacity 200kg. Set includes 2pcs. Price is stated for 1pc /No. 6066/

set 34.80

★ **5 years WARRANTY**  
TITANIUM HEAT EXCHANGER  
COMPRESSOR

★ **2 years WARRANTY\***  
ON SPARE PARTS



EURO PALETTE packed, FUMIGATED  
**17.50€/1pc** (Depending on the model it is possible to pack more units on EUP (2-6pcs).)



v. 01/2025

**MICROWELL**

28 kW  
135 m<sup>3</sup>

## HP 2800 SILVER Inverter Pro

Cover	COP	Heating output	Heating output BOOST	Cooling output
ALUMINIUM	24.1 - 1.93	28.54 - 5.78 kW (A27 W26 RH80)*	30.0 kW (A27 W26 RH80)	11.9 kW (A35 W28)*



**FULL YEAR**  
-20~43°C



### HP 2800 SILVER Inverter Pro Compact



**Basic equipment:** Price EXW w/o VAT /EUR/

Heat pump /full stepless inverter DC compressor, brushless DC ventilator, GoldFin/, including 4-way valve hot gas defrost and EEV, condensate tray defrost, WINTER module, WiFi, Touch control, user's manual **4950**

anti VIBRATION + ultra QUIET + easy INSTALL +

#### Equipment:

**Protection cover:**  
**Heavy duty** waterproof UV resistant cover\* 210  
**Standard** heat pump seasonal cover 40  
*\*/Rebate does not apply on this item. This is the actual purchase price./*

**Rubber base installation block** 600mm - black, carrying capacity 200kg. Set includes 2pcs. Price is stated for 1pc /No. 6066/ set 34.80

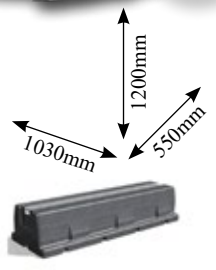

Protection cover

Rubber base installation block

### HP 2800 SILVER Inverter Pro Split - 1.



**Basic equipment:** Price EXW w/o VAT /EUR/

Split heat pump - separate water unit with remote installation /full stepless inverter DC compressor, brushless DC ventilator, GoldFin/, including 4-way valve hot gas defrost and EEV, condensate tray defrost, WINTER module, WiFi, Touch control, user's manual **5 450**

anti VIBRATION + ultra QUIET + easy INSTALL +

#### 1. Control display placement:

**S** standard: control display placed on the heat pump 0  
**E** external: wall installation (out of the heat pump), includes wall plaster box IP44, 10m cable, additional touch controller with Wi-Fi 190

#### Equipment:

**Rubber base installation block** 600mm - black, carrying capacity 200kg. Set includes 2pcs. Price is stated for 1pc /No. 6066/ set 34.80



Rubber base installation block

**5 years WARRANTY**  
TITANIUM HEAT EXCHANGER  
COMPRESSOR

**2 years WARRANTY\***  
ON SPARE PARTS



EURO PALETTE packed, FUMIGATED  
**17.50€/1pc** (Depending on the model it is possible to pack more units on EUP (2-6pcs).)





# COMPACT versus SPLIT

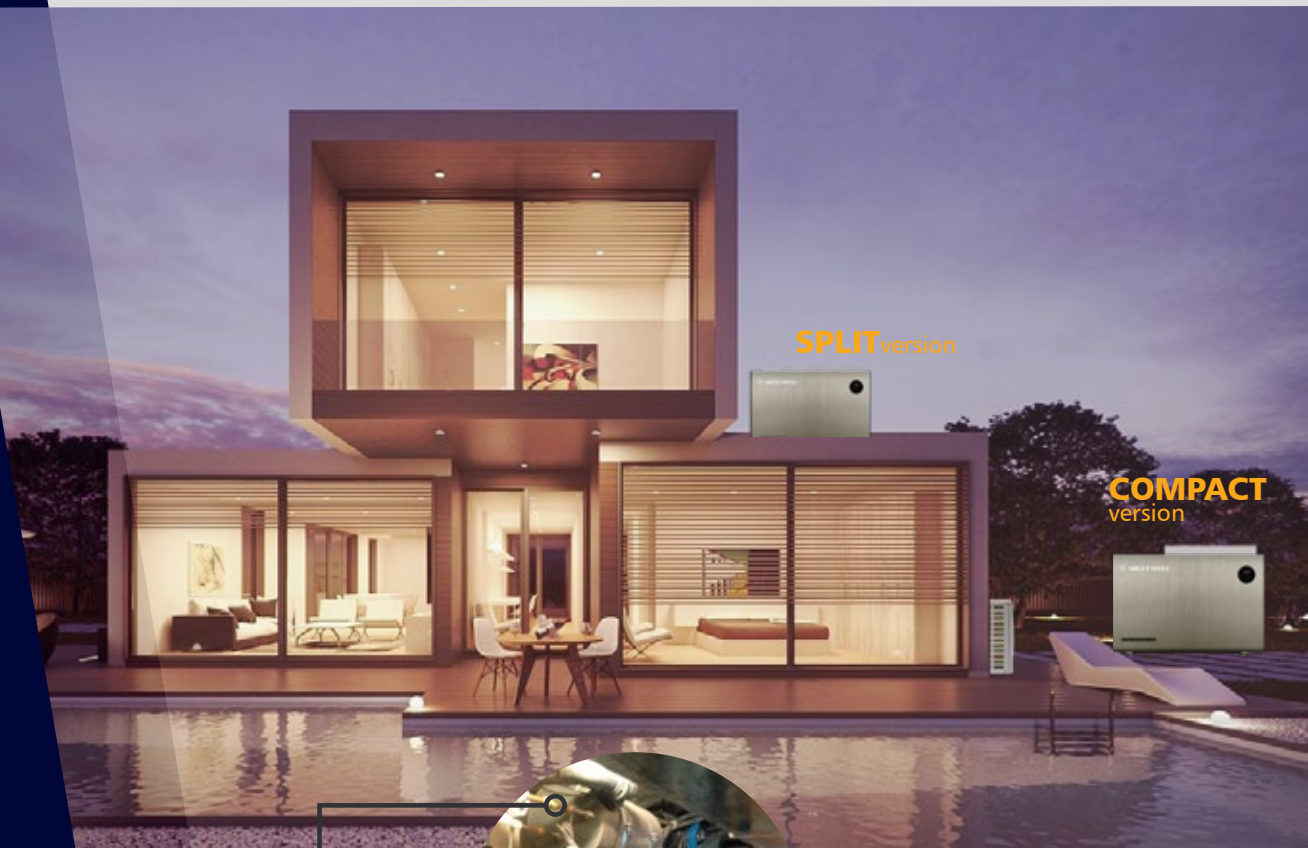

WATER EXCHANGER

TECHNICAL POOL ROOM

- Comfortable full year heating
- Winterizing is not necessary
- No noise, no vibration, no visual distraction



”

Split heat pump does not require winterizing because its water exchanger is placed in a place where it does not freeze, such as e.g. technical pool room, cellar or land.

”

24.4 kW 80 m <sup>3</sup>	<b>HP 2400 PREMIUM Compact</b>			30.1kW 120 m <sup>3</sup>	<b>HP 3000 PREMIUM Compact</b>		
	Cover	COP	Heating output		Cooling output	COP	Heating output
	metal	6.5 - 8.5 (A26 W26)*	22.2-28.8 kW (A26 W26)*	21.7 kW (A30 W35)*	6.5 - 8.5 (A26 W26)*	27.4-35.5 kW (A26 W26)*	26.8 kW (A35 W28)*

**FULL YEAR**  
-15~40°C

**TROPICAL**  
-5~60°C



**HP 2400 PREMIUM C**



EXCHANGER EQUIPPED with  
**1.2m<sup>2</sup>**  
of TITANIUM

**HP 3000 PREMIUM C**



EXCHANGER EQUIPPED with  
**1.4m<sup>2</sup>**  
of TITANIUM

Basic equipment:	Model:	Price EXW w/o VAT /EUR/
------------------	--------	----------------------------

- Heat pump (including GoldFin),
- Full year operation down to -15°C (including complete Winter package: condensate tray defrost, heat exchanger frost protection, winter module),
- Tropical kit allowing operations up to +60°C ambient air,
- Water cooling down to +5°C (chiller),
- Wi-Fi by standard TUYA IOT based App for iOS/Android Smart "POOL VISION",
- Remote wall controller including 30m cable,
- Thermally insulated water exchanger,
- User's manual

- micro COMPRESSOR+**    **micro ECONOMY+**
- anti VIBRATION+**    **anti FREEZE+**    **ultra QUIET+**

Equipment:		
<b>Protection cover:</b> Heavy duty waterproof UV resistant cover <i>/Rebate does not apply on this item. This is the actual purchase price./</i>	290	
<b>Rubber base installation block 400mm</b> - black, carrying capacity 200kg. Set includes 2pcs. Price is stated for 1pc / No. 6065/	set 26.40	

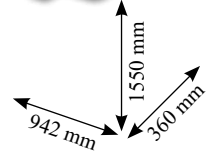

Protection cover



Rubber base installation block



Cable

**EURO PALLETTE** packed, FUMIGATED  
**17.50€/1pc** (Depending on the model it is possible to pack more units on EUP (2-6pcs).)



Smart Life

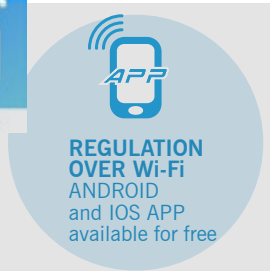

30.1kW  
120 m<sup>3</sup>

# HP 3000 PREMIUM Split

# Traditional excellence, built to last.

**FULL YEAR**  
-15~40°C

**TROPICAL**  
-5~60°C



## HP 3000 PREMIUM S



EXCHANGER  
EQUIPPED with  
**1.4m<sup>2</sup>**  
of TITANIUM

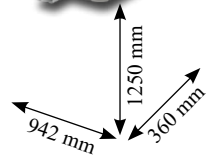

Protection cover



Rubber base installation block

### Basic equipment:

- Air unit (including GoldFin) + Hydro kit (without box)
- Full year operation down to -15°C, (including complete Winter package: condensate tray defrost, winter module),
- Tropical kit allowing operations up to +60°C ambient air,
- Water cooling down to +5°C (chiller),
- Wi-Fi by standard TUYA IOT based App for iOS/Android Smart "POOL VISION",
- Remote wall controller including 30m cable,
- Thermally insulated water exchanger,
- User's manual

micro COMPRESSOR +

micro ECONOMY +

anti VIBRATION +

anti FREEZE +

ultra QUIET +

### Model:

**HP 3000  
PREMIUM  
Split**

**Price EXW**  
w/o VAT /EUR/

**6 250**

### Equipment:

**Rubber base installation block 400mm** - black, carrying capacity 200kg. Set includes 2pcs. Price is stated for 1pc /No. 6065/

set 26.40



EURO PALLETTE packed, FUMIGATED

**17.50€/1pc**

(Depending on the model it is possible to pack more units on EUP (2-6pcs).)

# TROPICAL

ALLOWING HEAT PUMP USAGE  
IN AMBIENT AIR FROM **+42°C**  
TO **+60°C**.



v. 01/2025

**MICROWELL**

FULL YEAR SWIMMING POOL HEAT PUMPS



50-450kW	<b>MAX ON-OFF</b>				50-473kW	<b>iMAX INVERTER</b>			
	Cover	COP	Heating output	Cooling output		COP	Heating output		Cooling output
	Metal	5.7 (A27 W27)*	50 - 450 kW (A27 W27)*	30 - 270 kW (A35 W28)*		6.2 - 16.1 (A27 W27)*	50 - 473 kW (A27 W27)*		25 - 250 kW (A35 W28)*

50-60Hz  
Compatible

T1-T3  
Panasonic  
compressors

3 year  
warranty

16units  
Cascade

-10°C~55°C  
ambient

Heating &  
cooling

Wi-Fi  
Built-in



**MAX/ iMAX 50 - 125**



**MAX/ iMAX 150 - 350**



**MAX/ iMAX 450**

Model MAX/ iMAX		50	125	150	250	300	350	450	
Compressor type						On-Off / Inverter			
Power Supply	V/PH/Hz	380/3/50-60							
Heating Capacity(A27W26)	kW	50	125	150	250	300	350	450	
	BTU/h	170.600	426.500	511.800	853.000	1.023.600	1.194.200	1.535.400	
COP (A27W26)		5.9	6.2	6.1	6.1	6.2	5.9	5.9	
Input Power (A27W26)	kW	9	21	26	43	51	60	77	
Input Current (A27W26)	A	16	40	49	81	97	113	146	
Heating Capacity(A15W26)	kW	35	88	105	175	210	245	315	
	BTU/h	119.500	298.600	358.260	597.100	716.520	835.940	1.074.780	
Input Current (A15W26)	A	15	36	43	72	87	101	130	
Cooling Capacity(A46W30)	kW	30	75	90	150	180	210	270	
	BTU/h	101.455	253.638	245.700	409.500	511.800	573.300	737.100	
EER (A46W30)		3.0	3.1	3.0	3.0	3.1	3.0	3.0	
Input Power cooling (A46W30)	kW	10	25	30	50	60	70	90	
Input Current cooling (A46W30)	A	19	47	57	95	114	133	171	
Compressor type		Scroll							
Compressor Qty		2	2	2	4	4	6	6	
Fan Qty		2	2	2	2	2	6	6	
Noise	dB(A)	60	65	65	68	70	95	80	
Water Flow Volume	m <sup>3</sup> /h	12	30	30	60	72	84	90	
Water Pressure Drop	kpa	18	30	30	55	56	77	90	
Fan Direction		vertical							
Refrigerant Type		R410A/R407C							
Unit Net Dimensions ( L/W/H )	mm	1500X800X1230	2050X1065X2010	2050X1065X2010	2300X1350X2360	2300X1350X2360	3000X2000X2300	3000X2000X2300	
Unit Shipping Dimensions (	mm	1540X900X1380	2150X1200X2200	2150X1200X2200	2400X1520X2560	2400X1520X2560	3150X2100X2500	3150X2100X2500	
Package Weight		228	1003	1180	1920	2117	2790	3126	
40 Feet container quantity		16	10	10	5	5	3	3	
Operating ambient temperature		(-10°C - +43°C) / (0°C+55°C)							

**Designed for public /commercial applications such as public pools, hotel pools, school pools.**

125m<sup>3</sup> – 520m<sup>3</sup> Pool Available

# Main Features:

**Commercial Microwell MAX / iMAX air source swimming pool heat pump is designed for heavy duty heating and cooling pool jobs in 4 season environment as well as in tropical conditions.**

- ▶ Designed for **EUROPEAN WEATHER** from -10°C to +43°C and for **MIDDLE EAST WEATHER** 0°C to +55°C
- ▶ **Durable metal** design with multiple compressor system
- ▶ **Titanium Grade1** ASTM B265M used inside water heat exchangers designed to work **fresh, salt or chlorine** water
- ▶ Vertical fan discharge for ideal placement in noise damping chambers
- ▶ **GoldFin** hydrophobic epoxy protection of the fins **against sea wind, sand, dust** and effective de-icing
- ▶ Automatic overheat control to ensure heating and cooling in peak day time hot weather
- ▶ Automatic defrost to ensure heating operations during winter time
- ▶ Wide heating capacity with **50kW to 450kW** provided by a **single unit**
- ▶ Primary phase monitor protection against incorrect order of the phases or missing phase
- ▶ T1/T3 Panasonic compressors with built-in automatic control logic for more energy saving
- ▶ **Multiple fan speed** mode to support low noise
- ▶ Electronic expansion valve for more precise refrigerant flow for maximum COP and kW at each weather condition
- ▶ Centralized control of up to **16 heat pumps** (BMS)
- ▶ WIFI control compatible
- ▶ **3 years** general spare parts warranty
- ▶ On-site service support possible
- ▶ **15 years** of experience with applications







**We are flexible in design and can provide unit as per your request. For example we can alter standard series height and reduce it as per your demand.**

**Units are made with utmost care. They are fully tested for performance not only in lab conditions but also in real life.**

**We can provide full documentation (e.g. manual, quick start-up guide, Modbus protocol, technical drawings, visuals, etc.)**

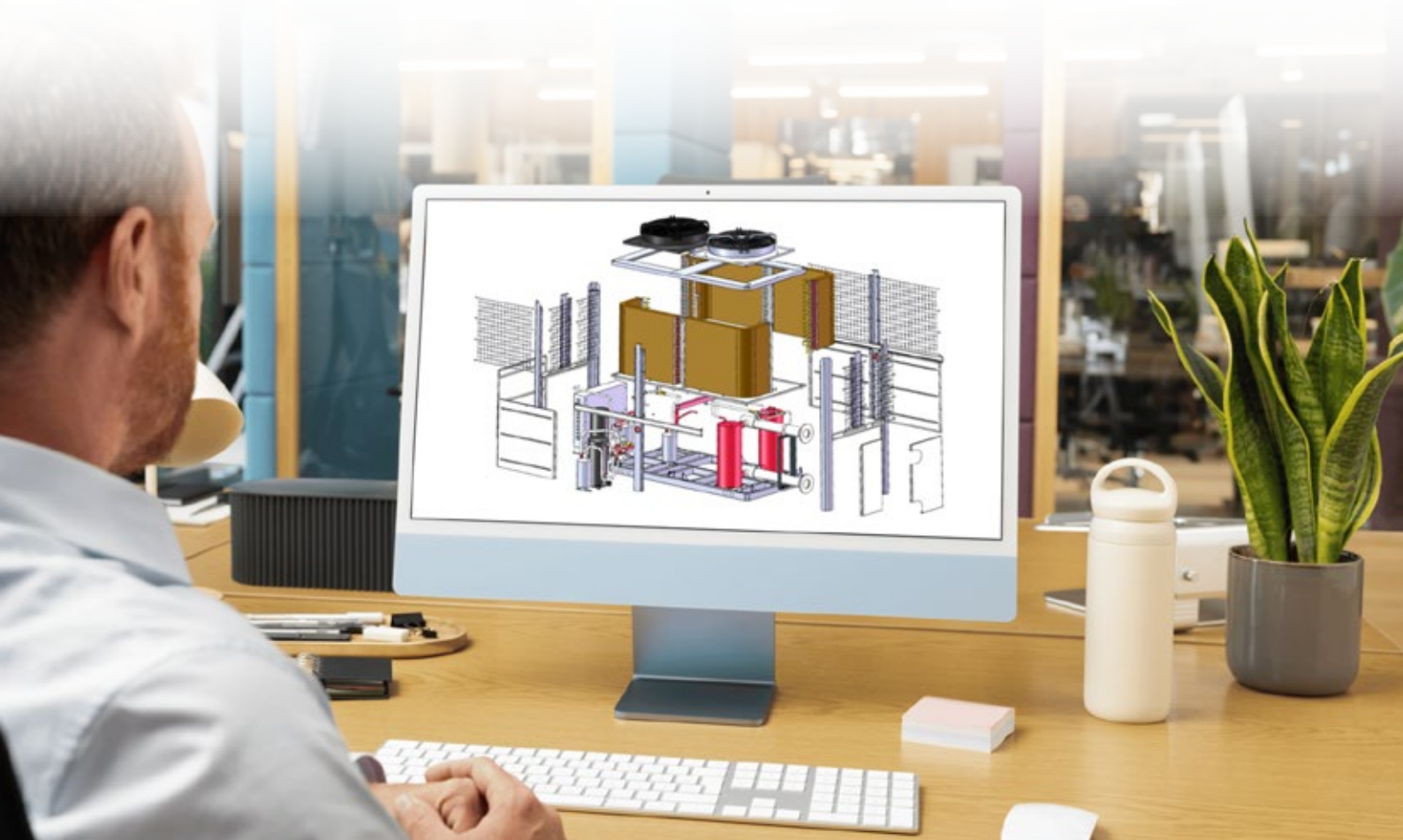



# MULTIPLE Heat pump

up to 800m<sup>3</sup>



- Apply multiple Microwell heat pump units
- Up to **20pcs** in parallel connection
- Up to **700kW** power
- Save on transport & handling costs
- Make the maintenance & service easier and cheaper
- Use Smart step regulation
- ModBus available



# ACCESSORIES & Spare parts

---

Measurement and regulation  
Installation material and equipment  
Spare parts  
Water surface covering  
Ventilation

**The widest selection of finishes  
and accessories.**

**Benefits that customers desire**

Based on close relationship with  
customers, Microwell provides  
functionality through matchless  
selection of accessory options.



# Qmax - Heat pump TESTER

Save up to  
**30%**  
on energy  
bill



FOR SETTING THE QUALITY  
**of pool performance**

www.microwell.eu

ACCESSORIES & Spare parts

Carry-on measurement device designed to provide measurement and optimization of heat pump's performance and efficiency

Price EXW  
w/o VAT /EUR/

**Basic equipment:**

- Carry on measurement device with inductive flow meter KROHNE Optiflux 2050 with connection DN50
- A pair of mobile WIKA Pt100 resistance thermometers
- Measurement device



**1. Qmax-TESTER**

**measures:** water temperature inlet & outlet, true heating or cooling output, heat pump power consumption, water flow  
**counts:** Coefficient of performance /COP/, Energy efficiency ratio /EER/

**2 890**

**2. Heat pump's OPTIMIZATION**

executed by a Microwell trained technician

**99**



**IMMEDIATE TESTING**  
OF A HEAT PUMP



**COMPATIBLE**  
WITH ALL 1 PHASE HP

WATCH VIDEO & LEARN MORE



/General discount does not apply on above stated prices. Stated prices are final./

v. 01/2024





# 1. FLOAT SWITCHES FOR EQUALIZING TANKS

Float switches for equalizing tanks	Price EXW w/o VAT /EUR/
-------------------------------------	----------------------------

## 1.1. NIVOCONT - conductive level switch

<b>1.1.A</b> KSN-201 - probe from stainless steel	<b>33.60</b>
---	--------------

<b>1.1.B</b> KRK-512-5 - relay	<b>47.30</b>
--------------------------------	--------------

## 1.2. NIVOFLOAT - plastic level switch

<b>1.2.A</b> NLP-110 - plastic level float switch (PVC cable 10m)	<b>31.80</b>
---	--------------

## 1.3. NIVOPOINT - multiple switching point magnetic level switch:

<b>1.3.A</b> MRA-210-3 - multiple switching point level switch with wetted parts from stainless steel (1" thread, 2 switching points, probe tube 1m)	<b>204.00</b>
--	---------------

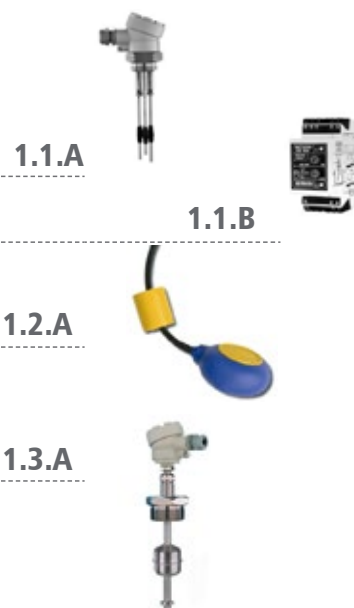

# 2. HUMIDITY AND TEMPERATURE METER in 1

Device for indoor humidity and temperature measuring	Price EXW w/o VAT /EUR/
--	----------------------------

## 2.1. Thermo-humidistat BEURER HM 16

Humidity 20% to 95% Air temperature 0°C ~ +50°C Selection °C/°F Wall installation / flipping holder Well readable display Measurement accuracy ± 5% Battery 1x 1.5V	<b>14.40</b>
---	--------------

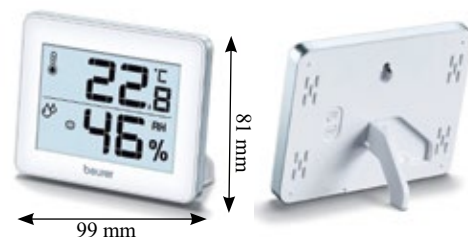

## 2.2. PROFESSIONAL- GFTH 95 (professional application)

Humidity measurement accuracy: ± 1,5% 1 line LCD Battery included 1x 9V, typ IEC 6F22 Body: ABS	<b>153.00</b>
--	---------------



/Change in price and offered products reserved./

### 3. HUMIDITY VISUALIZATION

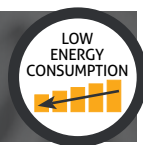

microLIGHT+

Price EXW  
w/o VAT /EUR/

#### 3.1. microLIGHT+ INFINITY

Operational temperature range: 0°C ... +60°C.  
Compatibility: All DRY range

3.1.A microLIGHT+ INFINITY, length 1 m	183.00
3.1.B microLIGHT+ INFINITY, length 3 m	213.00
3.1.C microLIGHT+ INFINITY, length 5 m	228.00

#### 3.2. microLIGHT+ LAMP

A freestanding table lamp.  
MicroLIGHT+ LAMP measures and automatically reflects current relative humidity, changing the colour gradient between blue, green and red colour.

3.2.A microLIGHT+ LAMP	105.00
------------------------	--------

/Change in Lamp model reserved./

#### 3.3. microSTEAM+

Operational temperature range: 0°C ... +120°C.  
Designed for ceilings of the swimming pool halls as LED humidistat for saunas.

3.3.A microSTEAM+, length 1 m	229.00
3.3.B microSTEAM+, length 2 m	253.00

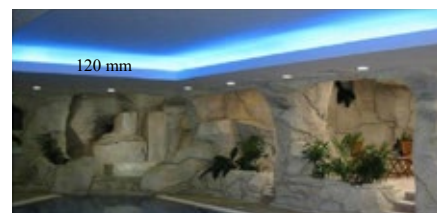

ACCESSORIES & Spare parts

Low humidity 0-40% RH

Ideal humidity 40-60% RH

High humidity 60-100% RH

microLIGHT+

Integrated LED light strip indicating current humidity in a pool. Light spectrum from blue (humidity low) through green (all OK) to red (problem – humidity high) in full color gradient.

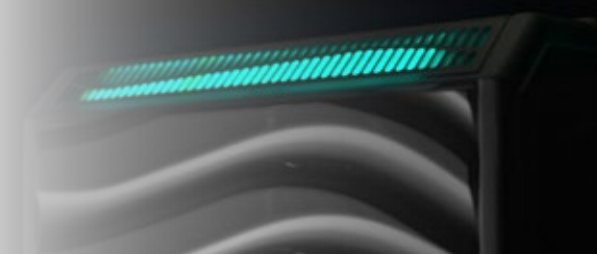

## 4. FLOOR GRILLS

Price change reserved

/Actual price to be quoted based on an individual enquiry./

Price EXW  
w/o VAT /EUR/

### 4.1. Basic structure

4.1.A	Symmetrical ASS	from <b>154.00</b>
4.1.B	Asymmetrical ASU	from <b>160.00</b>
4.1.C	Asymmetrical removable ASR	from <b>207.00</b>
4.1.D	LED Asymmetrical removable ASR	from <b>352.00</b>



### 4.2. Fixation

4.2.A	Mounting rail AS-BF	from <b>34.50</b>
4.2.B	Substructure channel AS-UBK	from <b>252.00</b>

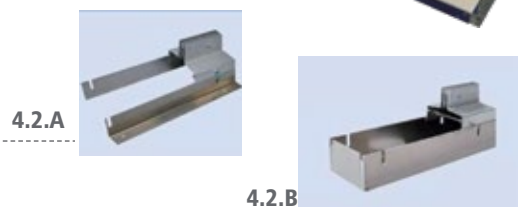

### 4.3. Accessories

4.3.A	Comer AS-GS	from <b>69.90</b>
4.3.B	Diffuser AS-DLV	from <b>11.40</b>
4.3.C	Construction works protection cover AS-AP	from <b>6.50</b>
4.3.D	Cut out for substructure channel AS-UBK-A	from <b>13.00</b>
4.3.E	Substructure channel socket AS-UBK-ZSR	from <b>28.40</b>
4.3.F	Side cut out with socket for mounting rail or substructure channel AS-UBK-ZS	from <b>28.40</b>
4.3.G	End cover AS-END	from <b>16.80</b>
4.3.H	Condensate drain for substructure channel AS-UBK-AS	from <b>47.00</b>

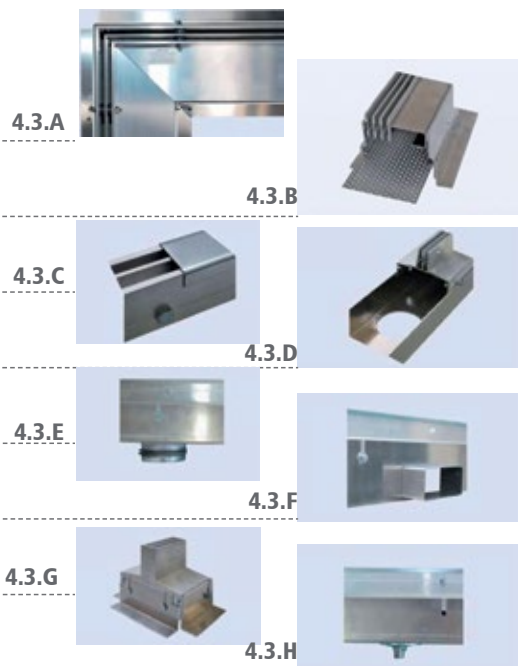

/Price change reserved./





## 5. INSTALLATION MATERIAL

5.1 for SWIMMING POOL DEHUMIDIFIERS installation		unit	Price EXW w/o VAT /EUR/
<b>Pumps and accessories</b>			
<b>7102</b>	Pump SI 83 – condensing, with tank 2l, 500l/h, max. 4.2m /No. 7012/	1 pc	<b>79.00</b>
<b>7100</b>	Condensate hose 16mm internal / 20mm external flexible /No. 7100/	1 standard meter	<b>0.95</b>
<b>Cleaning and disinfection appliances</b>			
<b>5008</b>	Easy Care spray – evaporator cleaner and disinfection /No. 5008/	1 pc	<b>14.10</b>
<b>In-wall condensate siphons</b>			
<b>7103</b>	In-wall condensate siphon, DN32/20 /No. 7103/	1 pc	<b>32.00</b>
<b>Anti odor siphons</b>			
<b>7102</b>	Siphon (anti-odor trap) for condensation hose /No. 7102/	1 pc	<b>7.00</b>
5.2 for SWIMMING POOL HEAT PUMP installation		unit	Price EXW w/o VAT /EUR/
<b>Copper pipes</b>			
<b>2011</b>	for HP900/1100 BLACK SPLIT, HP1100 SILVER INVERTER Pro SPLIT Insulated double copper pipes DUO 6+12 (1/4" + 1/2" x 0.8) - <b>25m package</b> /No. 2011/	1m	<b>6.50</b>
<b>2012</b>	for HP1500/1700/2100 SILVER Inverter Pro SPLIT, HP 1500 BLACK Insulated double copper pipes DUO 10+16 (3/8" x 5/8") - <b>25m package</b> /No. 2012/	1m	<b>10.00</b>
<b>2003</b> <b>2007</b>	for HP2300/2800 INVENTOR, HP2400/3000 PREMIUM, HP2700 SILVER INVERTER Pro SPLIT Insulated copper pipes d10 (3/8" x 1.0)- <b>50m package</b> /No. 2003/ + insulated copper pipes d18 (3/4" x 1.0)- <b>25m package</b> /No. 2007/	1m	<b>13.00</b>
<b>2005</b> <b>2003</b>	for DRY SIREN Insulated copper pipes d12 (1/2" x 1.0)- <b>50m package</b> /No. 2005/ + insulated copper pipes d10 (3/8" x 1.0)- <b>50m package</b> /No. 2003/	1m	<b>10.50</b>
<b>Insulation tape</b>			
<b>5.2.2.A</b>	A self-adhesive insulation tape K-flex white /No. 2016/	1 pc	<b>13.40</b>
<b>Consoles and base blocks</b>			
<b>6004</b>	Console White - 700, 2 pcs	set	<b>44.00</b>
<b>6061</b>	Base installation block 450 – white, carrying capacity 200kg, 2pcs /No. 6055/, with Side covers, 4 pcs	set	<b>8.60</b>
<b>6065</b>	Rubber base installation block <b>400mm</b> - black, carrying capacity 200kg. Set includes 2pcs. Price is stated for 1pc <b>Compatibility:</b> HP 900 - 1100 BLACK	set	<b>26.40</b>
<b>6066</b>	Rubber base installation block <b>600mm</b> - black, carrying capacity 200kg. Set includes 2pcs. Price is stated for 1set. <b>Compatibility:</b> HP 1100-1500-1800-2100-2800 SILVER INVERTER Pro, HP2300-3000, INVENTOR & PREMIUM, HP 1500 BLACK	set	<b>34.80</b>
<b>6023</b>	Antivibration silentblocks, 4pcs	set	<b>16.80</b>



/Price change reserved./

General discount does not apply on above stated prices. Stated prices are final.



## 6. EQUIPMENT FOR INSTALLATION AND SERVICE

Price change reserved



Price EXW  
w/o VAT /EUR/

### 6.1. Vacuum pump

**6.1.A** Vacuum pump Rothenberger ROAIRVAC 6,0 - 170l/min **325**

6.1.A



**6.1.B** Refco - ENVIRO DUO OS, recovery station with oil separation - 4687035, gas 33kg/h, liquid 210 kg/h, Push pull 570kg/h **1 140**

6.1.B



### 6.2. Charging and testing hoses Refco

**6.2.A** Premium with closure valve, length 90cm **50**

**6.2.B** Premium with closure valve, length 150cm **60**

6.2.A|B



### 6.3. Manifold valve Refco

**6.3.A** for refrigerant R410, R32 **95**

6.3.A



**6.3.B** for refrigerant R22, R407, R410 **85**

6.3.B

### 6.4. Eccentric flare tool

**6.4.A** Eccentric flare tool Rothenberger, with 1" flare matrix, 222402 **150**

6.4.A



**6.4.B** Eccentric flare tool REFCO, with 1" flare matrix in small suitcase, RF888Z **120**

6.4.B



**6.4.C** Eccentric flare tool REFCO, flare matrix and cutter in small suitcase, RF275FS **90**

6.4.C



**6.4.D** Flare tool Rothenberger with expanding - 1" packet **55**

6.4.D



### 6.5. Expanders

**6.5.A** Expander Rothenberger 3/8, 1/2, 5/8, 3/4, 22, 28 - 1" packet, 12320 **340**

6.5.A



### 6.6. Cutters

**6.6.A** Cutter Rothenberger MINIMAX 3 - 28mm, 70015 **25**

6.6.A



**6.6.B** Cutter Rothenberger TC 35, 6- 35mm, 70027 **30**

6.6.B



### 6.7. Tube benders

**6.7.A** Tube bender Rothenberger TBM 3/8, 1/2, 5/8, 3/4, 7/8, 23022X **225**

6.7.A



### 6.8. Charging scales

**6.8.A** Charging scale Rothenberger to 120kg - accuracy 2g, 173004 **275**

6.8.A



**6.8.B** Charging scales TST **170**

6.8.B



/Price and model change reserved./

# 7. WATER CONNECTION PACKET

Price change reserved



for HEAT PUMP CONNECTION to pool water circuit

	/Price for the whole set/	Price EXW w/o VAT /EUR/
<b>7. 1.</b>	<b>WATER CONNECTION PACKET for HP Premium, Inventor</b>	<b>155.00</b>
<b>7. 2.</b>	<b>WATER CONNECTION PACKET for HP SILVER Inverter Pro</b>	<b>135.00</b>



1 Pressure hose d50, length 10m /No. 211055/

2 PVC tube d50, length 0.8m /No. 211061/

3 Tube holder, open, d50, 8pcs /No. 211050/

4 Hose nut / Swivel for glue d50 x external thread 1 1/2", 2pcs /No. 211049/

5 PVC tube knee 90° for glue, 8pcs /No. 211046/

6 Swivel with valve for glue d50, 3pcs /No. 211048/

7 PVC "T" piece 90° for glue d50, 2pcs /No. 211047/

8 Glue Tangit PVC-U, 250g /No. 211051/

9 Cleaner Tangit 125 ml /No. 211052/

10 Sealing fibre Tangit Uni-Lock, 1 package /No. 211054/

11 Teflon tape 12 mm/12 m /No. 211053/

12 Screw fasteners with screws, 8pcs, dimensions: 10x48mm /No. 206013/

13 Screw fasteners with screws, 8pcs, dimensions: 6x70mm /No. 206023/

14 Cardboard box, 800x600x600 mm /No. 210005/

/Price change reserved./

General discount does not apply on above stated prices.  
Stated prices are final.



**SMART PURCHASE**  
Buy the whole set.



/Picture is illustratory./

ACCESSORIES & Spare parts



v. 01/2025





## 8. SPARE PARTS

### 8.A.

### DEHUMIDIFIER SPARE PARTS

Price EXW  
w/o VAT /EUR/

Order code	Compressors	Price
<b>103322</b>	Compressor DRY 300: including siphon, silentblocks, heat protection, cover, Daikin OEM	<b>305</b>
<b>112003</b>	Compressor DRY 300: including siphon, silentblocks, heat protection, cover, LG	<b>485</b>
<b>103008</b>	Compressor DRY 500: including siphon, silentblocks, heat protection, cover, Daikin OEM	<b>415</b>
<b>112004</b>	Compressor DRY 500: including siphon, silentblocks, heat protection, cover, LG	<b>575</b>
<b>103015</b>	Compressor DRY 800: including siphon, silentblocks, heat protection, cover	<b>840</b>
<b>103016</b>	Compressor DRY 1200: including siphon, silentblocks, heat protection, cover	<b>1 065</b>
<b>103005</b>	Compressor capacitor DRY500: 30mF	<b>10</b>
<b>103050</b>	Compressor capacitor DRY300/400: 40mF	<b>10</b>
<b>103018</b>	Compressor capacitor DRY800/1200:	<b>12</b>



Order code	Compressor	Price
<b>103022</b>	Humidistat & Thermostat DIGITAL (FOX-2SHTR) BUILT-IN SILVER, METAL a DUCT	<b>126</b>
<b>103020</b>	Mechanical built-in humidistat /rotary/ ALL DEHUMIDIFIER MODELS	<b>29</b>
<b>103021</b>	Indication wheel for rotary humidistat / ALL DEHUMIDIFIER MODELS	<b>2</b>
<b>103026</b>	Mechanical external rotary humidistat EBERLE HYG-6001	<b>80</b>
<b>103028</b>	Mechanical external rotary humidistat EBERLE HYG-7001	<b>85</b>
<b>RHT-RX</b>	Receiver for wireless humidistat & thermostat DRY EASY 300	<b>70</b>
<b>RHT-TX-2</b>	Transmitter for wireless humidistat & thermostat DRY EASY 300	<b>215</b>
<b>RHT-ANT</b>	Antenna for wireless humidistat & thermostat DRY EASY 300	<b>60</b>
<b>103464</b>	Main board of dehumidifier controller DRY (SW:SRO193040-1) PCB	<b>180</b>
<b>103465</b>	Round touch controller DRY (SW: SRO193039) wih WiFi	<b>85</b>



Order code	Sensors for	Color	Price
<b>103471</b>	T1 SH humidity sensor 80cm CHTM-02NA-800-XH	White	<b>15.00</b>
<b>103468</b>	T2 Compressor discharge 50kohm copper head sensor 120cm CC.T37	Red	<b>CC.T452 4.50</b>
<b>103466</b>	T3 Suction/Condenser 5kohm copper head sensor 120cm CC.T43	Black	<b>CC.T118 3.50</b>
<b>103474</b>	T4 Evaporator 5kohm copper head sensor 120cm CC.T43	Yellow	<b>CC.T189 3.00</b>
<b>103469</b>	T5 Air temperature 5kohm plastic head sensor 80cm CC.T45	White	<b>CC.T45 3.00</b>



Order code	Sensors for DRY800-1200	Color	Price
<b>103472</b>	T1 SH humidity sensor 1500cm CHTM-02NA-1500-XH	White	<b>15.00</b>
<b>103468</b>	T2 Compressor discharge 50kohm copper head sensor 120cm CC.T37	Red	<b>CC.T452 4.50</b>
<b>103467</b>	T3 Suction/Condenser 5kohm copper head sensor 200cm CC.T63	Black	<b>CC.T336 3.50</b>
<b>103475</b>	T4 Evaporator 5kohm copper head sensor 200cm CC.T63	Yellow	<b>CC.T337 3.50</b>
<b>103470</b>	T5 Air temperature 5kohm plastic head sensor 150cm CC.T112	White	<b>CC.T112 3.00</b>



## 8. SPARE PARTS

### 8.A.

### DEHUMIDIFIER SPARE PARTS

Price EXW  
w/o VAT /EUR/

Order code	Valves	Price
<b>103004</b>	LP valve - DRY 300/400	<b>19</b>
<b>103010</b>	LP valve - DRY 500/800/1200	<b>19</b>
<b>103059</b>	Time relay JEL-111 - ALL DEHUMIDIFIER MODELS	<b>35</b>
<b>103058</b>	Power relay Finder - DRY 300/400/500/800/1200 30A	<b>19</b>
<b>103069</b>	Power relay OMRON DRY 800/1200	<b>25</b>
<b>108001</b>	Filling valve d6/100mm, SAE 1/4" ALL DEHUMIDIFIER MODELS	<b>3</b>
<b>103019</b>	Antifreeze thermostat +15°C	<b>35</b>

Order code	Capilla	Price
<b>108006</b>	Capillary DRY300, length: 1m	<b>5.50</b>
<b>108016</b>	Capillary TLEX 2.0, DRY400	<b>5.50</b>
<b>108006</b>	Capillary DRY500, length: 2.6 m	<b>10.50</b>

Order code	Refrigerant filters and air filters	Price
<b>108032</b>	Refrigerant filter Castel 300/400/500	<b>11.00</b>
<b>108022</b>	Refrigerant Filter DRY800/1200	<b>14.00</b>
<b>F1</b>	Air Filter DRY300/400 TTW, G3	<b>5.00</b>
<b>F2</b>	Air Filter DRY500 TTW, G3	<b>5.00</b>
<b>F3</b>	Air Filter DRY800/1200 TTW, G3	<b>5.00</b>
<b>F4</b>	Air Filter DRY300/400 DUCT, G3	<b>6.00</b>
<b>F5</b>	Air Filter DRY500 DUCT, G3	<b>7.00</b>
<b>F6</b>	Air Filter DRY800/1200 DUCT, G3	<b>9.00</b>

Order code	Fans	Price
<b>103442</b>	Fan for DRY 300-400-500-800-1200. DRY300-400 - 1pc/dehumidifier, DRY500-800-1200	<b>142</b>
<b>103009</b>	Ventilator DUCT 300/500/800/1200 Ziehl-Abegg	<b>240</b>
<b>103012</b>	Fan capacitor DUCT DRY 500-800-1200: 3.5µF 400/450V	<b>10</b>

General discount does not apply on above stated prices.  
Stated prices are final.



## 8. SPARE PARTS

### 8.B.

### HEAT PUMP SPARE PARTS

Price EXW  
w/o VAT /EUR/

Order code	Flow switch	Price
<b>203005</b>	Flow switch HP1000-1100-1400-1500-1700-2300-2400-2800-3000	<b>35</b>
<b>Exchangers</b>		
<b>204003</b>	Exchanger Inventor HP2300	<b>425</b>
<b>204004</b>	Exchanger Inventor HP2800	<b>525</b>
<b>Controllers</b>		
<b>HP18010</b>	Controller - complete set HP1000, 2000, 30000, SW-SRO193032, SRO193033	<b>199</b>
<b>203022</b>	Controller - Transformer	<b>20</b>
<b>203008</b>	Controller - Wall installation box	<b>3</b>
<b>Wi-Fi box</b>		
<b>203051</b>	WIFI box SRO193034, 2x 1m connection cable, female and male connector	<b>30</b>
<b>Temperature sensors</b>		
<b>203011</b>	Temperature sensor T1, T2, T5 (water, evaporator) (k5Ω)	<b>3</b>
<b>203013</b>	Temperature sensor T3 (air, plastic) (k5Ω)	<b>3</b>
<b>203012</b>	Temperature sensor T4 (compressor)(k50Ω)	<b>3</b>





## 8. SPARE PARTS

### 8.B.

### HEAT PUMP SPARE PARTS

Price EXW  
w/o VAT /EUR/

Order code	Fan blades	Price
<b>209045</b>	Fan blade HP 1000-1100-1400-1500	<b>50</b>
<b>209035</b>	Fan blade HP 2300-2400-2800-3000	<b>50</b>
<b>209029</b>	Fan Motor HP 2300-3000	<b>150</b>

Compressors		
<b>209083</b>	Compressor HP1000-1100, GMCC Rotary	<b>550</b>
<b>209084</b>	Compressor HP1400-1500, GMCC Rotary	<b>660</b>
<b>209090</b>	Compressor HP2300-2400, Panasonic Scroll	<b>790</b>
<b>209089</b>	Compressor HP2800-3000, Panasonic Scroll	<b>890</b>

Others		
<b>209024</b>	4-way valve electrical coil + copper valve HP1000-1100-1400-1500	<b>30</b>
<b>209034</b>	4-way valve electrical coil + copper valve HP2300-2400-2800-3000	<b>30</b>
<b>HP18020</b>	Set of silentblocks (4pcs)	<b>18</b>
<b>HP18021</b>	Condensate drain "L" part 90°	<b>3</b>
<b>209029</b>	Fan Motor C048 HP2300-2800-2400-3000	<b>150</b>
<b>209031</b>	Phase monitor HP2000-3000	<b>60</b>



General discount does not apply on above stated prices.  
Stated prices are final.

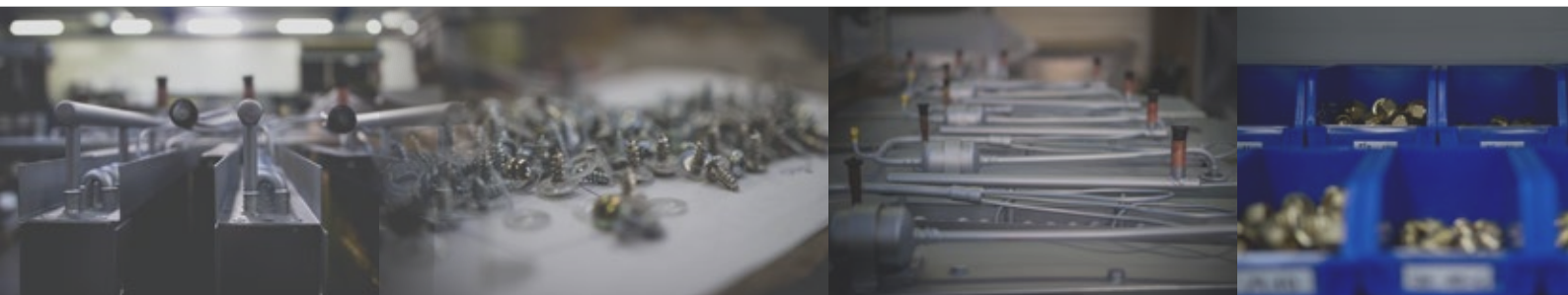

## 8. SPARE PARTS

### 8.C.

#### HEAT PUMP SPARE PARTS for models HP SILVER

Price EXW  
w/o VAT /EUR/

##### Round touch controller DRY (SW: SRO193039) with WiFi

Fan Blade	<b>40</b>
Fan Motor	<b>110</b>
Main Control Board	<b>210</b>
Reactor	<b>20</b>

##### HP1500 SILVERINVERTER PRO (220-240V~/50Hz)

Fan Blade	<b>70</b>
Fan Motor	<b>120</b>
Main Control Board	<b>250</b>
Reactor	<b>20</b>

##### HP1800 SILVERINVERTER PRO (220-240V~/50Hz)

Fan Blade	<b>70</b>
Fan Motor	<b>120</b>
Main Control Board	<b>250</b>
Reactor	<b>20</b>

##### HP2100 SILVERINVERTER PRO (220-240V~/50Hz)

Fan Blade	<b>70</b>
Fan Motor	<b>120</b>
Main Control Board	<b>340</b>
Reactor	<b>20</b>

##### HP2800 SILVERINVERTER PRO (380-415V/3N~/50Hz)

Fan Blade	<b>40</b>
Fan Motor	<b>110</b>
Main Control Board	<b>120</b>
Driver Board	<b>540</b>
Reactor	<b>20</b>

##### Universal Spare Parts for all the SIP Models

Water Flow Switch	<b>35</b>
Inlet/Outlet Water Connection (50mm)	<b>10</b>
Exhaust Temperature Sensor (compressor)	<b>3.00</b>
Temperature Sensor can be used for Coil Temperature, Suction Temperature, Cooling Coil Temperature, Inlet and Outlet Water Temperature	<b>3.00</b>
Ambient Temperature Sensor	<b>4.00</b>
Wire Controller Extended Cable (0.8m)	<b>10</b>
Wire Controller with Wi-Fi (Round Shape)	<b>70</b>

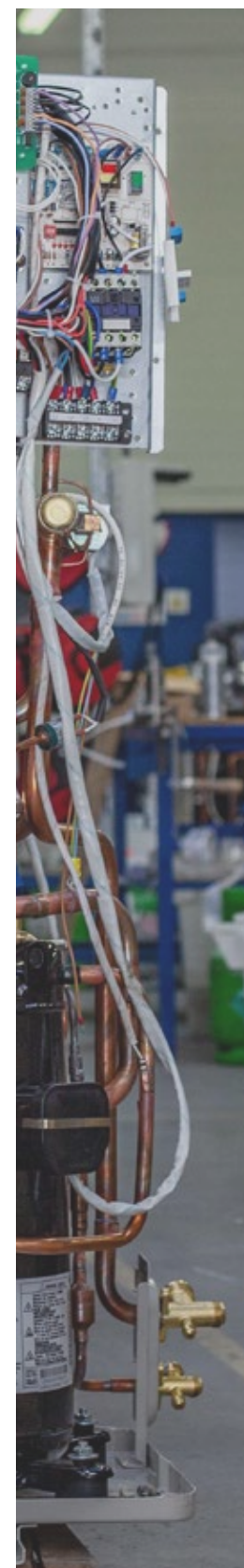

## 9. WATER SURFACE COVER

Price change reserved

A swimming pool cover reduces the actual evaporation by 30-50%. This means that you need a smaller dehumidifier for a given pool, you will save on energy bill since smaller unit consumes less electricity and also you will reduce heat losses of your water, thus you will need smaller heating device (heat pump) and also it will consume less energy compared to pool without cover.

Blue bubble plastic cover is a perfect solution for a domestic or hotel pool.



### 9.1 POOL COVER ROLLER

Price EXW

w/o VAT /EUR/

#### 9.1.1. Pool cover roller - FIXED POSITION

**9.1.1.A** with telescopic tube length 2.7 - 4.4m **188**

**9.1.1.B** with telescopic tube length 3.7m - 5.4m **208**

**9.1.1.C** with telescopic tube length 4.1m - 5.7m **185**

**9.1.1.D** with telescopic tube length 5.3m - 6.9m **210**

#### 9.1.2. Pool cover roller - MOBILE

**9.1.2.A** with telescopic tube length 2.7 - 4.4m **200**

**9.1.2.B** with telescopic tube length 3.7m - 5.4m **218**

#### 9.1.3. Pool cover roller - SIDEWISE MOBILE

**9.1.3.A** with telescopic tube length 2.7 - 4.4m **250**

**9.1.3.B** with telescopic tube length 3.7 - 5.4m **275**

#### 9.1.4. Pool cover roller - STANDING

**9.1.4.A** with telescopic tube length 2.7 - 4.4m **190**

**9.1.4.B** with telescopic tube length 3.7m - 5.4m **205**

#### 9.1.5. Pool cover roller - FIXED ON THE WALL

**9.1.5.A** with telescopic tube length 2.6 - 4.3m **280**



### 9.2 BLUE BUBBLE PLASTIC SHEET

Price EXW

w/o VAT /EUR/

400 micr., 50m reel up, Light blue Geo Bubble material /m/

**9.2.A** width 3m **16.50**

**9.2.B** width 3.5m **19.50**

**9.2.C** width 4m **22.50**

**9.2.D** width 5m **27.50**

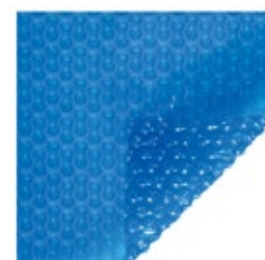

General discount does not apply on above stated prices. Stated prices are final.





# 10. VENTILATION

up to  
**300 m³/h**

**FREE**  
heated

## Fan scheme



**Price EXW**  
w/o VAT /EUR/

## 10.1. EXHAUST ventilation set

### 10.1.A Ventilation set A: Air flow: 100m³/h, Ø 100mm

Includes:

- Small axial extract fan DECOR 100
- Backdraft shutters RSK 100 ED
- Plastic external louvre LG100
- Plastic circular hose UK-PP 100/1000

**120**

### 10.1.B Ventilation set B: Air flow: 300m³/h, Ø 160mm

Includes:

- Small axial extract fan DECOR 300 SZ IPX4
- Backdraft shutters RSK 150 ED
- Plastic external louvre LG 150
- Plastic circular hose UK-PP 150/1000

**150**



**Price EXW**  
w/o VAT /EUR/

## 10.2. FRESH AIR ventilation set

### 10.2.A FRESH AIR ventilation set A: with Fixed plastic external louvre

- Air flow: 100-300m³/h, Ø 100mm
- white color - RAL 9010
- Includes: Plastic circular hose LG100, Plastic circular hose UK-PP 100/1000

**40**

### 10.2.B FRESH AIR ventilation set B: with Electric plastic back draft louvre shutter

- Air flow: 100-300m³/h, Ø 100mm
- grey color - RAL 7035
- Includes: External electric louvre PAR 160 RAL7035, Plastic circular hose UK-PP 100/1000

**400**

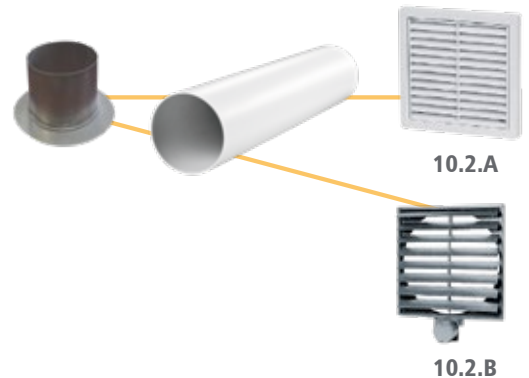

## Installation scheme

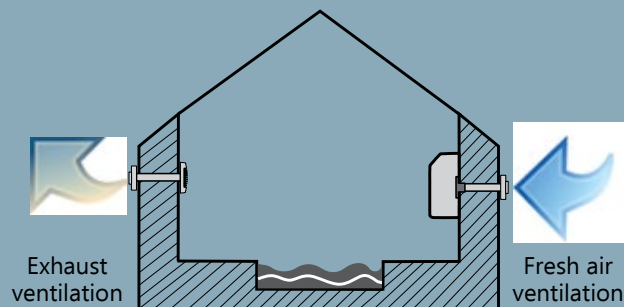

Bring fresh air into  
your pool  
and warm it with  
the dehumidifier.



### Our Innovation: **FRESH AIR SUPPLY**



Each Microwell dehumidifier has fresh air supply possibility. The air inlet is located under the condenser, that way the incoming fresh air is effectively heated at no cost thanks to heat recovery.



### ADDITIONAL VENTILATION

Saving energy,  
time & money

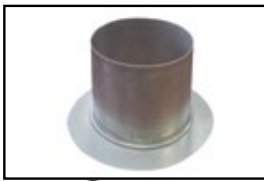

*Fresh air metal extension for connection to dehumidifier*



*Plastic circular hose*



*Plastic external louver*

Compatibility to All DRY range.

# LET'S CONNECT AND EXPLORE TOGETHER!

Join our community and be the first to know about our latest updates, exclusive offers, and behind-the-scenes moments. We love sharing insights, tips, and exciting news with you!



Facebook



Instagram

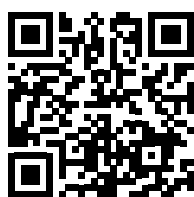

LinkedIn



YouTube

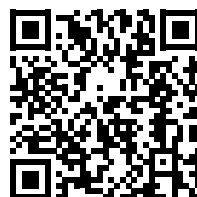

TikTok



## MICROWELL, spol. s r.o.

SNP 2018/42, 927 01 Šal'a, SLOVAKIA  
p (+421) 31/770 7082  
m (+421) 911/413 990  
e export@microwell.sk

[www.microwell.eu](http://www.microwell.eu)



### Branch office PRAHA

Hlavní 1195  
251 68 Hlubočinka - Sulice, CZ  
m (+420) 773 621 599  
m (+420) 608 855 364  
e praha@microwell.cz  
www.microwell.cz

### Branch office BRNO

Pražáková 66  
639 00 Brno, CZ  
p (+420) 549 257 241  
m (+420) 608 855 364  
e brno@microwell.cz  
www.microwell.cz

### Branch office OSTRAVA

Slévárenská 411/12  
709 00 Ostrava, CZ  
p (+420) 596 638 227  
m (+420) 608 855 364  
e ostrava@microwell.cz  
www.microwell.cz

### Branch office BUDAPEST

Attila út 4.  
1013 Budapest, HU  
m (+36) 30 875 58 51  
e microwell@microwell.hu  
www.microwell.hu

*Manufacturer reserves the right to change the technical and visual parameters without notice.*



**MICROWELL**